



NAVIGATIONAL
ECHO SOUNDER
SES-5000



- ✓ 10.4" WIDE COLOR LCD
- ✓ MAX,24HOURS LONG MEMORY
- ✓ ALARM FOR DESINATED DEPTH
- ✓ BUILT IN TERMAL PRINTER
- ✓ USER FRIENDLY MENU



IMO STANDARDS MSC.74(69) ANNEX 4



 **SAMYUNG ENC Co.,Ltd.**

Head Office : 69, Sangni-Ro, Youngdo-Gu, Busan, Korea, 606-083
Tel : 82-51-601-5530(Rep.) Fax : 82-51-413-4446

A/S Center : 1, Ilsanbong-Ro, Yungdo-Gu, Busan, Korea, 606-819
Tel : 82-1577-0198(ARS) Fax : 82-51-416-5515

FEATURES

DISPLAY MODE

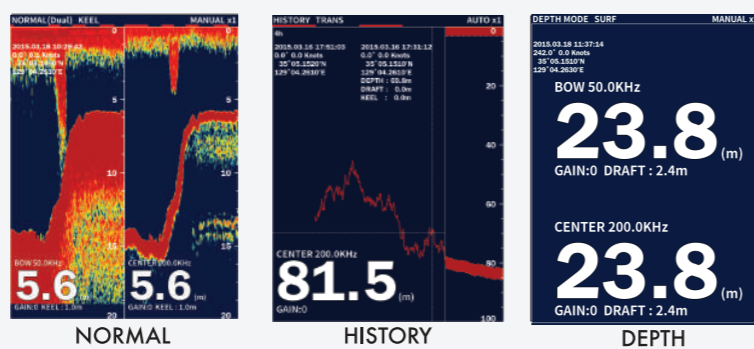

Select a desired screen mode.

SES-5000

Range mode
Display mode
Time bar
Display speed

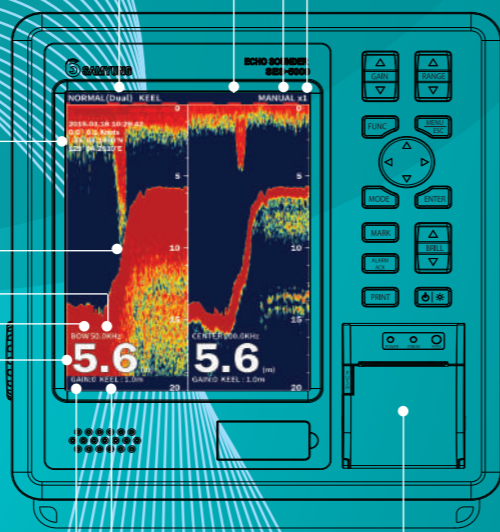

MARK

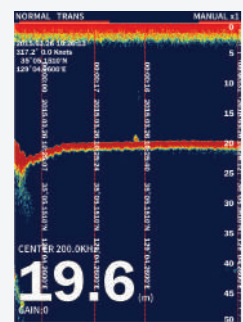

Mark lat/lon, time and location

PRINTER

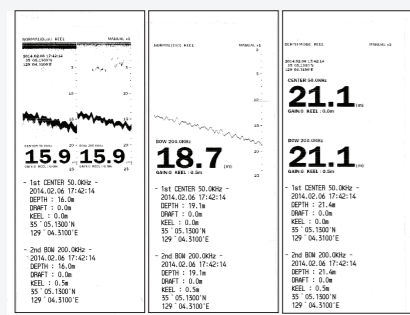

(Paper width : 57mm)

Print the data displayed on the current screen.

ALARM

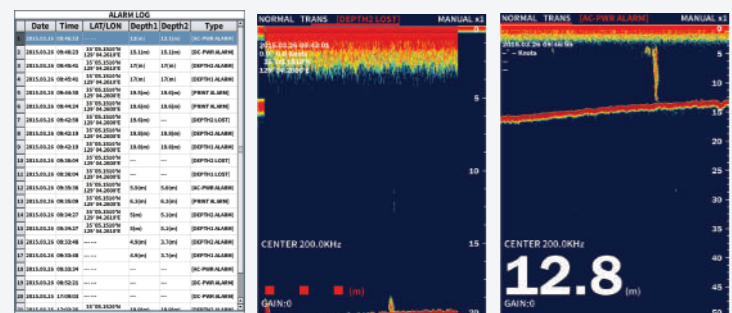

Last 99memorized alarm logs display, last 20 memorized alarm log printed. When printer becomes abnormal, AC power failed alarm alerts.

BACKGROUND

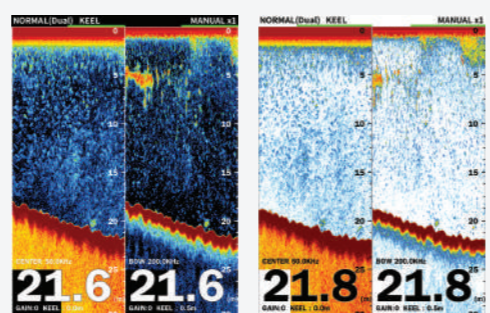

Change background color according to the surrounding environment.

Display

Display	10.4 color LCD(600x800 pixel)
Frequency	50KHz / 200KHz
Output Power	1kw,1.5kw
Color	8/16/64 colors, Background : Selectable among 5 colors
Range	5,10,20,50,100,200,500,800,1000m
Depth accuracy	+2.5%
Minimum sounding depth	50KHz : 1.7m, 200KHz : 0.6m
Draft	0-50m
Display mode	Single, Dual, Replay, Depth
Screen speed	x4, x2, x1, x1/2, 1/4, 1/8, Stop
Alarm function	Depth, Power fail, System error
Auto display	Auto gain(fishing/sailing), Auto depth
Noise reduction	Off, Light, Medium, Strong or Frequency adjustment (Range depends o transducer)
Replay function(Data storage)	24hrs(30secs save interval)
Time mark	30secs
Software Version	1.0.0

Power supply	Main 100-230VAC, 50/60Hz ±5% Sub 22-30VDC
Operation environment	Temperature : Main equipment -15°C - +55°C Humidity : Less than 93% (+30°C - +60°C)

Interface

Number of port	NMEA0183 VER1.5/2.0/3.0(I/O)-2port
Input data	GGA, VTG, ZDA
Output data	DBT, DBS, DPT, GGA, GLL, GSA, GSV, VTG, ZDA
Output alarm signal	Depth, Power fail, System error

COMPONENT

Standard

Main unit	SES-5000
Installation set	
Manual	

Option

Interface unit	SB-340
Water temp sensor	T80
Depth indicator	SD-3000
Dimmer controller	DM-3001
Transducer tank	TE-2000-XX
Junction box	SJ-2000

DIAGRAM

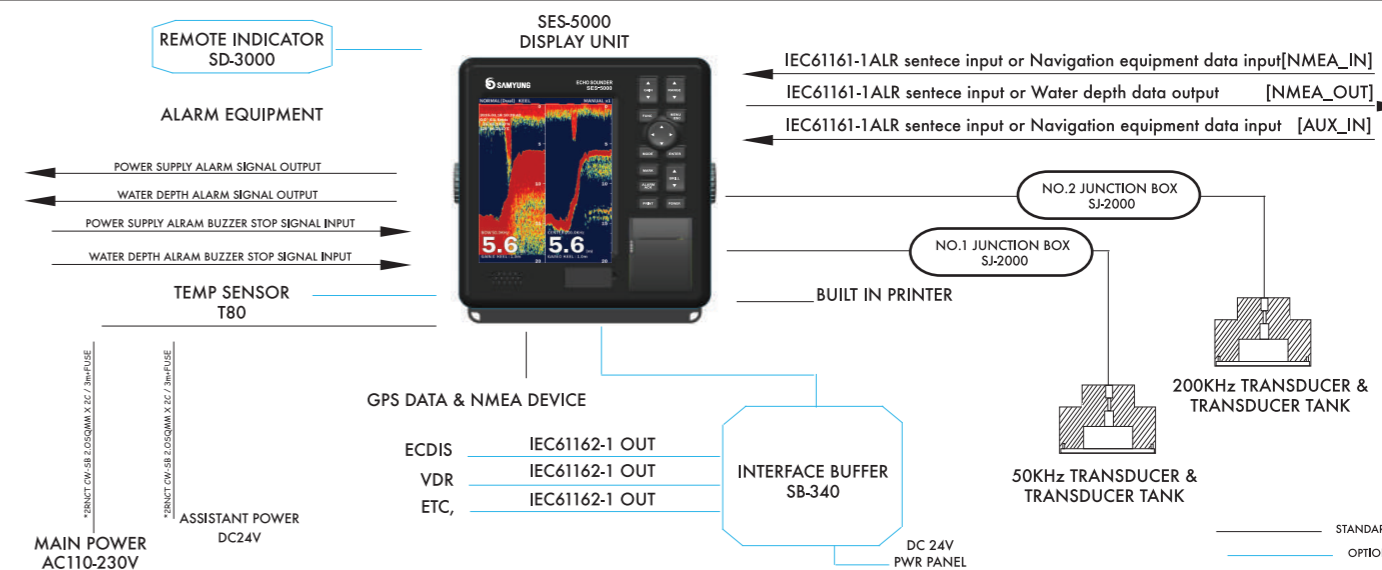

INSTALLATION

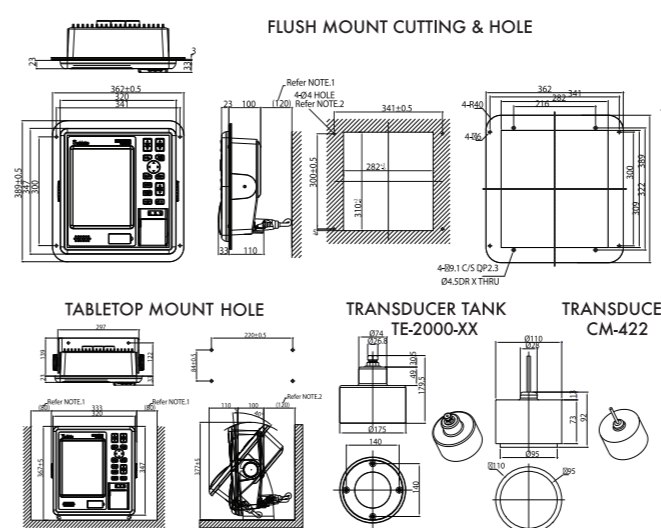

DIMENSION

