

1. OVERVIEW

The peculiarity of GMDSS is highly reliable communication by automation and digitalization.

SRG-1150DN/SRG-1250DN with SN-100 TERMINAL is consists of a MF/HF transmitter, MF/HF receiver, DSC(Digital Selective Calling) w/k receiver, NBDP receiver, DSC, distress alarm telephone. All of these are to communicate digitalized data properly for distress safety and general communication.

		SRG - 1150DN	SRG - 1250DN
The range of frequency		Transmission : 1.6MHz ~ 27.5MHz Receiving : 500KHz ~ 29.9999KHz	
The type of emission	J3E	150W(HIGH)/100W(MID)/50W(LOW)	250W(HIGH)/100W(MID)/50W(LOW).
	H3E	75W(HIGH)/16W(LOW)	75W(HIGH)/16W(LOW).
	F1B	100W(HIGH,MID)/75W(LOW)	150W(HIGH)/100W(MID)/75W(LOW)

1.1 FEATURES

(1) Possible range

Because MF/HF transceiver, DSC W/K receiver, DSC, Distress alarm telephone is built in SRG-1150DN/SRG-1250DN, you are able to use itself without NBDP terminal. NBDP function works by connecting SN-100 TERMINAL, but it is not available to use NBDP TERMINAL only.

(2) Total Control System

SRG-1150DN/SRG-1250DN is set up with the major modules combined as one unit or circuits within a single cabinet. Thus, it is possible to rationalize the total control system by interlinking the respective module controls.

And Narrow Band Direct Printing is available by connecting NBDP unit(SN-100) to SRG-1150DN/1250DN simply.

(3) Operability

All general operation such as communication, controls and monitoring, are performed by SRG-1150DN/SRG-1250DN, NBDP TERMINAL and printer which is installed in a convenient place.

DSC such as communication, editing messages and viewing received messages are performed by using the controller. Distress calls can be sent and received by one-touch operation in an emergency.

And it's easy to write up and Tx/Rx TELEX by using NBDP TERMINAL(SN-100), it is easy to figure out contents on a large front display.

(4) Configuration

SRG-1150DN/SRG-1250DN consists of one unit therefore, a large space is not required for operation. SN-100 TERMINAL is able to use by connecting with SRG-1150DN/SRG-1250DN cable.

(5) Trustworthy

Adopted new DDS(DIRECT DIGITAL SYNTHESIZE) and improved the quality of sound, trustworthy, stability.

(6) Construction

In order to endure in bad condition of marine environment, hard aluminum body is manufactured.

(7) External shape

Channel, frequency, transmitting and receiving conditions can be seen on large LCD at one sight. And each keys are made by soft rub material, it has stylish shape and makes you feel comfortable when you press the button. Futhermore there is frequency sheet for users.

SN-100 NBDP TERMINAL has large, thin, colorful LCD and convenient keyboard.

1.2 BASIC COMPONENTS

(1) SRG-1150DN + SN-100 (NBDP TERMINAL)

<< Standard Components List >>

NO.	DESCRIPTION	MODEL	Q'TY	REMARK
1.	MF/HF-DSC TRANSCEIVER	SRG-1150DN	1 SET	Assemble into SRG-1150DN
(1)	MOTHER BOARD	T - 570	1	
(2)	TX FILTER	T - 451	1	
(3)	MAIN	T - 454	1	
(4)	CONTROL	T - 557	1	
(5)	KEY BOARD	T - 568	1	
(6)	PLL SYNTHESIZE	T - 553	1	
(7)	W/K RECEIVER	T - 552	1	
(8)	TX POWER AMP	T - 514	1	
(9)	POWER SUPPLY	T - 555	1	
2.	NBDP TERMINAL	SN-100	1 SET	Assemble into SN-100
(1)	CONNECTION BOARD	T - 020	1	
(2)	NBDP RECEIVER	T - 022	1	
(3)	NBDP PLL	T - 023	1	
(4)	POWER SUPPLY	T - 025	1	
(5)	CPU BOARD	MSC655S	1	
3.	HAND MIC	SM-30	1	
4.	KEY BOARD	SPR8630	1	
5.	ANTENNA TUNER	SAT-100	1	
6.	POWER SUPPLY	SP-1250ADC	1	
7.	PRINTER	DPU-414	1	
8.	CONNECTION CABLE	CON1250	1	
9.	SPARE PART, INSTALLATION PART	SPR1250	1	
10.	INSTRUCTION MANUAL, INSTALLATION DIAGRAM		1	
11.	SPEAKER	SS-10W4	1	
12.	WHIP ANTENNA	SAN-30R	1	
13.	MF/HF ANTENNA	Reverted L-TYPE ANT.	1	
14.	EMERGENCY LIGHT	EMG-LIGHT	1SET	

<< Option List >>

NO.	DESCRIPTION	MODEL	QUANTITY	REMARK
1.	ALARM BOX	SD-250		OPTION
2.	MF/HF ANT (WHIP)	KUM-803		OPTION

(2) SRG-1250DN + SN-100 (NBDP TERMINAL)
<< Standard Component List >>

NO.	DESCRIPTION	MODEL	Q'TY	REMARK
1.	MF/HF-DSC TRANSCEIVER	SRG-1250DN	1 SET	Assemble into SRG-1250DN
(1)	MOTHER BOARD	T-570	1	
(2)	TX FILTER	T-461	1	
(3)	MAIN	T-454	1	
(4)	CONTROL	T-557	1	
(5)	KEY BOARD	T-568	1	
(6)	PLL SYNTHESIZE	T-553	1	
(7)	W/K RECEIVER	T-552	1	
(8)	TX POWER AMP	T-524	1	
(9)	POWER SUPPLY	T-555	1	
2.	NBDP TERMINAL	SN-100	1SET	Assemble into SN-100
(1)	CONNECTION BOARD	T-020	1	
(2)	NBDP RECEIVER	T-022	1	
(3)	NBDP PLL	T-023	1	
(4)	POWER SUPPLY	T-025	1	
(5)	CPU BOARD	MSC655S	1	
3.	HAND MIC	SM-30	1	
4.	KEY BOARD	SPR8630	1	
5.	ANTENNA TUNER	SAT-100	1	
6.	POWER SUPPLY	SP-1250ADC	1	
7.	PRINTER	DPU-414	1	
8.	CONNECTING CABLE	CON1250	1	
9.	SPARE PART, INSTALLATION PART	SPR-1250	1	
10.	INSTRUCTIONAL MANUAL, INSTALLATION DIAGRAM		1	
11.	SPEAKER	SS-10W 4	1	
12.	WHIP ANT(TX/RX)	SAN-30R	1	
13.	MF/HF ANT	REVERTED L-TYPE ANT	1	
14.	EMERGENCY LIGHT	EMG-LIGHT	1	

<< Option List >>

NO.	DESCRIPTION	MODEL	QUANTITY	REMARK
1	ALARM BOX	SD-250		OPTION
2	DSC ANT (WHIP)	KUM-803		OPTION

2. SPECIFICATIONS

2.1 GENERAL SPECIFICATION

* SRG-1150DN/SRG-1250DN has been tested according to the recommendation standard of IMO.

o Frequency Range	Transmitting Part : 1.6MHz - 27.5MHz, 10Hz STEP Receiving Part : 500KHz - 29.9999MHz, 10Hz STEP
o Frequency Stability	SYNTHESIZER method, deflection within 10Hz. (less than 0.3ppm)
o Frequency Selection	All ITU CHANNEL (maritime service) Calling 300 USER CHANNEL is able to be edited on the screen, or set frequency directly with keyboard. One-touch selection of 2182KHz (H3E), and 2187.5, 4207.5, 6312, 8414.5, 12557, 16804.5KHz(F1B) is SCAN receiving all the time.
o Frequency Switching Time	Between channels - within 5 seconds, Between bands - within 15 seconds. (INCLUDE ANTENNA MATCHING TIME)
o Type of Emission	USB(J3E), H3E, FSK(F1B)
o Communication Method	SIMPLEX and SEMI DUPLEX
o Ambient Condition	* Temperature : -15 ~ +55 * Humidity : 95%, +55 * Oscillation : full amplitude 3.2mm at 5 - 12.5Hz full amplitude : 0.8mm at 12.5 - 25Hz full amplitude : 0.2mm at 25 - 50Hz
o Power Supply	DC24V(BAT) - 10% ~ +30%, 40A max. AC100-120/200-240V, 50/60Hz ±6% single-phase 3.3KVA max. (in case of using power supply)
o Dimensions	* SRG-1150DN/1250DN : 288(W) X 312(H) X 166(D) (unit : mm) * SN-100 : 300(W) x 255(H) x 125(D) (unit : mm)
o Weight	SRG-1150DN/SRG-1250DN : 8.5Kg SN-100 : 5Kg

2.2 MF/HF TRANSMITTER

o Frequency Range	1.6MHz - 27.5MHz
o Continuous Work	Operation for over 8hours with transmission for 1 min., stand-by for 4 min.
o Output Power	Using 50 ohm dummy load (MF/HF transmitter output) a) AC Power : 1.6MHz~27.5MHz, 150W pep b) DC Power : 1.6MHz - 27.5MHz, SRG-1150DN (150W pep) SRG-1250DN (250W pep)
o Power Reduction (3 steps)	SRG-1150DN (J3E 50/100/150W, F1B 75/100/100W) SRG-1250DN (J3E 50/100/250W, F1B 75/100/150W) 2182KHz : H3E 16/75W
o Type of Modulation	Low-power stage balanced modulation
o Frequency Deflection	Below 10Hz (within 0.3ppm)
o Occupied Bandwidth	J3E - - - Within 3KHz J2B - - - Within 0.5KHz
o Carrier Attenuation	40dB or more (at J3E)
o Spurious Attenuation	At J3E 1.5 - 4.5KHz 31dB or more 4.5 - 7.5KHz 38dB or more 7.5KHz or more 43dB or more At F1B/J2B 138Hz 15dB or more 276Hz 31dB or more 500Hz 43dB or more
o Overall Frequency	Deflection 6dB max. at 350 - 2,700Hz
o Overall Distortion & Noise	20dB or more
o Input Low Frequency	+10dB/-35dB, IMPEDANCE 600 ohm

2.3 MF/HF RECEIVER

(1) ALL BAND Receiver

o Frequency Range	500KHz - 29.9999MHz in 100Hz STEP
o Method of Reception	UP CONVERSION DOUBLE SUPERHETERODYNE Type using phase-locked digital frequency synthesizer 1st intermediate frequency : 49.455MHz 2st intermediate frequency : 455kHz
o Type of Reception	USB(J3E), FSK(F1B)
o Overall Distortion & Noise	With an input voltage of 30 μ V, the ratio between an audio frequency output of 1000Hz and its unwanted component is greater than 20dB
o AGC Characteristics	Change in audio frequency output for antenna between 3 μ V and 100mV is 10dB or less
o Voice Output	Max 5.6W or more
o Receiving Sensitivity	SSB is less than 3uV at freq. 500KHz ~ 29.9999MHz Only, SSB : (S+N+D)/(N+D) = 20dB, BAND width : 3KHz, output : 100mW
o Articulation	<p>± 120Hz</p> <p>* In case of DSC, NBDP Symbol error rate at a receiver input voltage of 1μV is 1×10^{-2}</p> <p>Only, Receiving Mode : FSK, BAND width : 0.3KHz</p> <p>a) The detailed characteristics 3KHz FILTER (for SSB)</p> <ul style="list-style-type: none"> - The passband below 6dB : 2.4KHz - 2.8KHz - The passband at an attenuation of 26dB : within than ± 1.7KHz - The passband at an attenuation of 46dB : within ± 1.9KHz - The passband at an attenuation of 66dB : within ± 2.1KHz <p>b) The detailed characteristics of 0.3KHz FILTER (for DSC, NBDP)</p> <ul style="list-style-type: none"> - The passband below 6dB is 270Hz-300Hz - Attenuation at ± 380Hz is 30dB or more - Attenuation at ± 550Hz is 60dB or more

o Frequency Stability	Within $\pm 10\text{Hz}$
o Image Freq. Interference Ratio	70dB or more
o Middle Freq. Interference ratio	80dB or more
o SPURIOUS RESPONSE	<p>70dB or more</p> <p>* In case of DSC, NBDP</p> <p>When a wanted signal of $10\mu\text{V}$ and an 31.6mV unwanted signal (excluding the range within 750Hz of the wanted signal) whose range of IF is three times that of the wanted signal, the symbol error rate is 1×10^{-2} or less.</p>
o Selectivity suppression	<p>With a wanted signal of $10\mu\text{V}$ and an unwanted signal that is effect than 3KHz from the wanted signal, an unwanted signal input voltage of 10m suppresses the wanted signal output to 3dB.</p> <p>* In case of DSC, NBDP</p> <p>With a wanted signal of $10\mu\text{V}$ and 1mV unwanted signal 500Hz from the want signal, the character error rate is less than 1×10^{-2}</p>
o Spurious emission	The power of emission from air antenna terminal is $4000\mu\text{W}$ or less.
o Nominal input load	50 ohm unbalanced

2.4 DSC(Digital Selective Calling) W/K RECEIVER

o Frequency	2187.5, 4207.5, 6312, 8414.5, 12577, 16804.5kHz
o Scanning reception	Scanning reception of above frequencies is continued up to 2 seconds for each frequency and stop only when detects a 100 baud dot pattern.
o Type of emission(Rx)	F1B
o Receiving sensitivity	Character error rate is 1×10^{-2} or less at receiving input voltage $1\mu V$.
o 1 signal selectivity	<ul style="list-style-type: none"> - 6dB bandwidth : 270Hz - 300Hz - 30dB bandwidth : within ± 380Hz - 60dB bandwidth : within ± 550Hz
o Frequency Stability	within ± 10 Hz
o SPURIOUS RESPONSE	With a wanted signal of $10\mu V$ and an $31.6mV$ zero modulated interference signal which excludes the range within 750Hz of the wanted signal, the character error rate is 1×10^{-2} or less.
o Spurious emission	The power of emission from air antenna terminal is $4000\mu W$ or less.
o Nominal input load	50 ohm unbalanced

2.5 AUTOMATIC ALARM

o Continuous Transmitting Period	50 sec.
o Frequency and Deflection	<ul style="list-style-type: none"> - Within 1300Hz $\pm 1.5\%$ - Within 2200Hz $\pm 1.5\%$
o Each Alarm for long & Error	250ms ± 50 ms
o Alarm Intervals	50ms
o Amplitude Rates of Alarm	Less than 1.2

2.6 MF/HF CONTROL

o Controlled items	receiver, transmitter, MF/HF receiver, DSC, DSC WATCH-KEEPING receiver, frequency PROGRAM
o DISTRESS	Transmit 2182kHz/H3E alarm
o Miscellanea	DISPLAY BOARD, INTERNAL / EXTERNAL LOUD SPEAKER selectivity HAND-SET input, DIMMER.
o MAIN PROCESSOR	V25 - 20MHz
o ROM	27C040 (512K BYTE)
o RAM	68C1000 (128K BYTE)
o Display	LCD BACK-LIGHT DISPLAY
o INTERFACE	<ul style="list-style-type: none"> · RS-232 INTERFACE - 2 CHANNEL equipment · PRINTER INTERFACE - 1 CHANNEL equipment (based on CENTRONICS INTERFACE)

2.7 DSC

o PROTOCOL	Complied with CCIR recommendation 493-3 and 541-2
o EMISSION	F1B/J2B, 100 BAUD
o Modulator	Output frequency : 1700Hz \pm 85Hz Output LEVEL : Max +10dBm (600 ohm unbalanced/balanced)
o Demodulator	Input frequency 1700Hz + 85Hz Input LEVEL : 20dBm ~ +5dBm (600 ohm unbalanced/balanced)
o Processor	10-bit error detection code as specified in CCIR 493-8 standard. * Correction of CLOCK transmission type CLOCK frequency : 14,000kHz CLOCK stability : within $\pm 5 \times 10^{-6}$

2.8 Narrow Band Direct Printing telegraphy (NBDP)

o PROTOCOL	Referring to CCIR recommendation 625, 476-4, 490491, 491-3 and CCIR recommendation F130.
o Calling MODE	Individual and group calling with 5-digit and 9-digit SELECT CALL number.
o Operating MODE	<ul style="list-style-type: none"> - ARQ (Auto Repetition Request) - CFEC (Collective Forward Error Correction) : more than one receiving station - SFEC (Selective Forward Error Correction) : one receiving station
o Status Display	POWER ON, STAND-BY, CALLED, CALLING, FREE. SIGNAL, ARQ, CFEC, SFEC, SEND, RECEIVER, PHASING, REPHASING, REPEAT, ERR etc.
o Coding	7-bit code 4B/3Y constant ratio mark signal (B:1785Hz, Y:1615Hz)
o Memory Capacity	16M
o System Parameter	OPERATOR DATA is written on Flash Disk with Programming and Back-up
o Center Frequency	1700Hz
o Frequency Shift Range	$\pm 85\text{Hz}$
o Modulation Speed	100 baud (ARQ, FEC mode)
o Modulation	Phase-continuous AFSK
o Frequency deviation	Within 0.5Hz
o Demodulation Input	0dBm, 600ohm unbalanced/balanced
o Modulation Output	0dBm, 600ohm unbalanced/balanced

2.9 PRINTER (DPU-414)

1. SPECIFICATION

- Type of printing : Terminal serial dot matrix
- Total dots : 9 × 320 dot / line
- Dots per character : 9 × 7 dot wide
- Space between character : 1 dot
- Characters per line : 40 characters(standard size), 80 Characters(reduced size)
- Line feed direction : forward, forward/reverse logical seek

2. BIT-IMAGE GRAPHICS MODE

- Total dots : 8 × 320 dot / line
- Line feed direction : forward logical seek
- Length of a line : 89.6mm
- Printing speed : 52.5cps max(standard size), 80cps max.(reduced size)
- Dimension : 160mm × 170mm × 66.5mm
- Weight : 580g approx.
- Average life : 500,500 line approx. when print "8" 40 characters
fully with 100% darkness

3. AMBIENT

- Temperature : 0 ~ 40
- Humidity : 30% ~ 80% RH(at no condensation)

4. PRINT PAPER

- Model No. : TP411 ~ 28CL (TP-411L)
- Width : 112mm
- Diameter : 48mm
- Length : 28m approx.

2.10 PRINT(OKI MICROLINE 280)

TECHNICAL FEATURES

o Major Applications

The entry level printer in the Oki 9-pin dot-matrix range, the ML 280 is fast and robust, yet compact and light. A true demand document printer with bottom feed and short tear, its special size makes it ideal for customer service environments and industrial workstation applications. :

- * Multi part continuous forms
- * Dedicated label printer
- * Data logging and personal use
- * Suited to harsh environments
- * Customer service and industrial workstation environments

o General Printer Characteristics

- * Number of pins : 9
- * No. of multi-part forms : 4(one original + 3 copies)
- * Print speed at : 12 cpi 10 cpi
- Super speed : 300 cps -
- High speed draft : - 240 cps
- Utility : 200 cps 200 cps
- Near letter quality : 50 cps 50 cps
- * Fastest print speed : 300 cps
- * Carriage width (10 cpi) : 80 columns
- Max. in compressed mode : 132 columns
- * Dimensions :
- Height : 80 mm
- Width : 360 mm
- Depth : 275 mm
- Weight : 4.5 Kg
- * Continuous Paper : 3 - 9.5"(76.2 - 241.33 mm)
- * First Printable Line : From top of page
- Cut Sheet : 0.59"(15 mm)
- Continuous : 0.67"(16.9 mm)
- * Character Pitch : 10/12/17 pitch & proportional
- * Graphics Resolution : Up to 216 X 240 dpi
- * Memory : Standard buffer 1 line
- * Noise Level : Less than 55 dBA
- * Power Requirements : 230V AC (+6%, -14%), 240V AC(±10%)
- * Frequency : 50/60 Hz

o Font & Print Features

- * Resident Typefaces (1) : Courier
- * Font Styles : Super Speed Draft.
NLQ High Speed Draft. Utility

o Interfaces & Emulations

- * Emulations : Epson FX or IBM Graphics of Oki MicroLine
- * Standard Interfaces : Centronics Parallel
- * Optional Interfaces : Serial RX 232C/RS 422/Current Loop

o Reliability

- * Print Head Life : 200 million characters
- * Black Ribbon Life : 3 million Characters (re-inking cartridge)
- * MTBF : 6000 hours

o Paper Handling

STANDARD

- * Autoload Single Sheet
- * Platen in Feed
- * Low tear-off
- * Paper end detection

OPTIONAL

- * Roll Paper Stand
- * Pull tractor feed
- * Single bin Sheet Feeder

o Other options

- * Optional ML 280 DC Voltage model - for use with 12 of 25 DC power supplies for such applications as 'on the road' printing in vehicles.

Paper path 1 : Rear paper feed for continuous forms
Paper path 2 : Bottom paper feed for
continuous forms with straight paper path
Paper path 3 : Top feed of single, cutsheet forms
Standard paper handling : Rear feed
Bottom feed
Top feed

3. POWER SUPPLY

3.1 POWER ON

- a) AC power plug put in plug receptacle, connect the battery with rear socket.
- b) AC and DC switch on.
- c) Check the indication of light on : AC IN, DC IN, DC OUT of Front panel.
- d) Connect cables between SRG-1150DN/SRG-1250DN and SN-100.
(Only when NBDP terminal is being used.)
- e) Press SRG-1150DN/SRG-1250DN [PWR] key.
- f) Press power switch of SN-100.(Only when NBDP terminal is being used.)

3.2 OPERATION BY AC POWER

When AC power is supplied to the main unit, it works with on AC power automatically. W/K LED displays the condition that 6 scanning frequency is working on DSC WKR of transceiver.

In this mode, if a DSC distress or DSC alarm call is received, the [DISTRESS] of [OTHERS] LEDs on MF/HF control panel will light up and the alarm tone is sounded.

(Refer to 'Operation of Distress Acknowledge Signal' on 1p for operation instructions if a DSC distress or DSC alarm call is received.)

3.3 OPERATION BY DC POWER

When AC power is disconnected, the SRG-1250DN switches to the DC operation and the [DC] LED on MF/HF control panel will light up automatically.

When it is transmitted to DSC, AC signal will be changed to DC on upside of transceiver LCD display. Moreover, changing to DC mode will be displayed on downside of that.

And receiving output is converted to LOW.

3.4 BATTERY CHARGING

When connected to AC power, except of switch on of transmitter power supply AMP power, the battery is automatically charged. While charging, a 20A static current is supplied to the battery, when fully charged, a low current is supplied to maintain the rated battery voltage. The charge mode indicator between automatic and normal is by the charge switch on the system cabinet.

- AUTO MODE - When the battery is low, automatically charge. The default is auto mode.
- NORMAL MODE - Regardless of battery status, charge the battery.
To make battery life long, it needs repair properly. Refer to the manual.

4. FRONT PANEL

4.1 EXPLANATION OF KEY, KNOB, LAMP OF MAIN UNIT

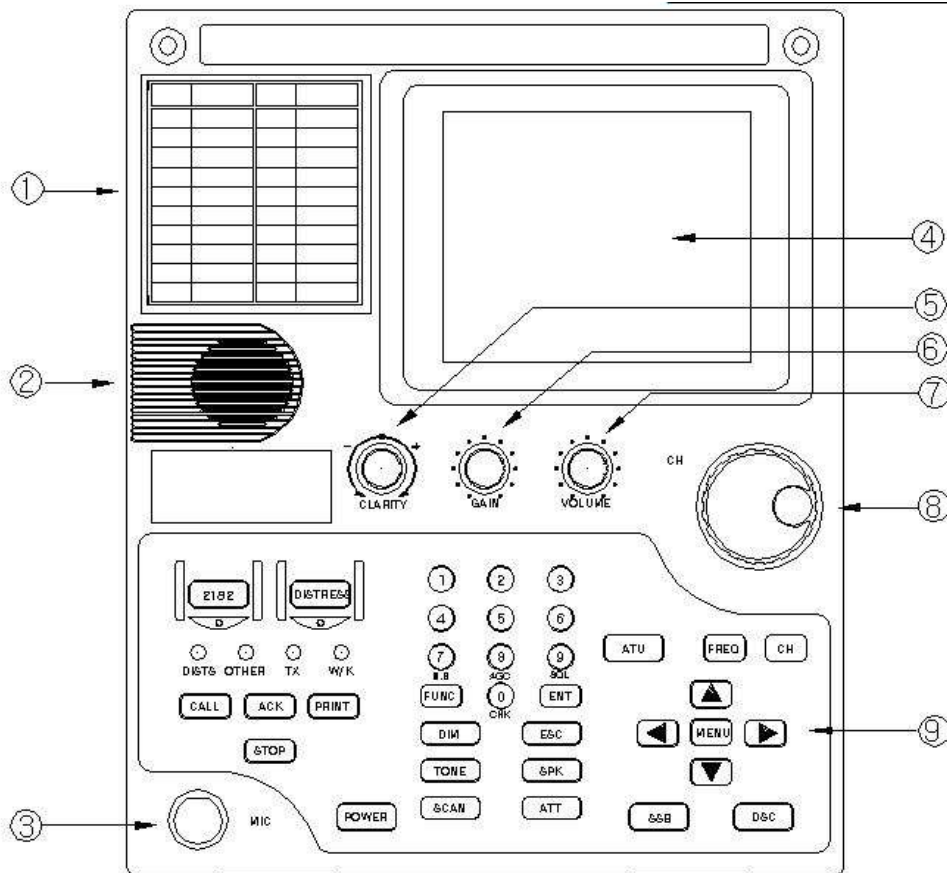

List sheet of channels and frequencies

INTERNAL SPEAKER

MIC. CONNECTION JACK - CONNECT SUPPLIED MIC.

FRONT PANEL (LCD) - DISPLAYS CHANNEL / FREQUENCY / MODE

ARTICULATION - ADJUST ARTICULATION(TO RECEIVE SIGNAL CLEARLY)

GAIN - ADJUST AF GAIN

VOL - ADJUST SPEAKER VOLUME

CHANNEL - ADJUST CHANNEL AND FREQUENCY UP AND DOWN

KEY PANEL

FREQUENCY	SELECT FREQUENCY
CHANNEL	SELECT CHANNEL
TONE	1.4KHz TEST TONE SIGNAL - ON / OFF
ATU	PRESS KEY WHEN USER MATCHES WITH ANTENNA
SPK	SPEAKER - ON / OFF
DIM	ADJUST LCD BACK LIGHT(INSIDE LIGHT) 2 STEPS.
SCAN	START AND FINISH CHANNEL SCAN RECEIVING
0~9	USE FIGURE KEY INPUT.
FNC	PRESS KEY WITH ANOTHER KEY CAN BE FUNCTION UP. * [FNC] + [7] - N.B ON/OFF * [FNC] + [8] - AGC ON/OFF * [FNC] + [9] - SQL ON/OFF * [FNC] + [0] - CHECK MODE. RECEIVING : RX SIGNAL OR POWER VOLTAGE(24V) TRANSMITTING : END CURRENT OR ANT CURRENT
POWER	POWER -ON / OFF.
CLR	CANCEL SETTING OR RETURN TO PREVIOUS MENU.
2182	TRANSMISSION MODE OF DISTRESS ALARM SIGNAL

EMG TX	PRESS FOR 5 sec., TO TRANSMIT DIGITAL DISTRESS SIGNAL.
▲ ~ ▼	SELECT TRANSMITTING OR RECEIVING CHANNEL, SELECT TRANSMITTING OR
◀ ~ ▶	RECEIVING CHANNEL, SELECT SETTING ITEMS AT DIGITAL SELECTIVE CALL MODE AND MOVE INVERTED ITEMS SELECT MAIN MENU.
ENTER	SELECT ITEMS INPUT EXPANSION
MENU	SELECT MAIN MENU
ATT	SELECT 2 LEVEL OF ATTENUATOR ON RECEIVING PART
CALL	SEND THE PRESENT FREQUENCY/CHANNEL MESSAGE
ANSWER	ANSWERING MODE ON/OFF
PRINT	PRINT RECEIVED FREQUENCY/CHANNEL
STOP	STOP ALARM, OFF THE INDICATORS OF DISTRESS, CALL.
SSB	COMMUNICATION MODE BY SSB TELEPHONE
DSC	COMMUNICATION MODE BY DSC

**** OTHER CONTROL PARTS ****

EMG LED INDICATOR - WHEN TRANSMITTING, LED INDICATOR IS TURNED ON

CALL LED INDICATOR - WHEN RECEIVING DSC SIGNAL, LED INDICATOR IS TURNED ON EXCEPT OF DISTRESS SIGNAL.

TX LED INDICATOR - WHILE TRANSMITTING, LED INDICATOR IS TURNED ON.

W/K LED INDICATOR - WHEN W/K RECEIVER IS ACTIVATED, LED INDICATOR IS TURNED ON.(ALWAYS WORKING)

H DISPLAY TRANSMITTING OUTPUT - H(250W), M(100W), L(F1B-75W,J3E-50W)

SCN PRESS [SCN] KEY, SHOW BELOW DISPLAY AND THEN START TO SCAN, PRESS [SCN] ONE MORE TIME, THEN STOP TO SCAN

2187		SCN	ACK=0	AC	H	15:00
------	---	-----	-------	----	---	-------

ACK=0 PRESS KEY - ON / OFF

ON

2187			ACK=0	AC	H	15:00
------	---	--	-------	----	---	-------

OFF

2187			ACK=X	AC	H	15:00
------	---	--	-------	----	---	-------

CH PRESSING [CH] KEY, [CH] IS INVERTED.

CHANNEL CAN BE CHANGED AFTER USING NUMBER KEY OF [CH] DIAL.

TX INVERTED [TX] KEY USING [FRQ] KEY, THEN ADJUST THE TX FREQUENCY WITH [CH] DIAL OR NUMBER KEY.

RX INVERTED [RX] KEY USING [FRQ] KEY, THEN ADJUST THE RX FREQUENCY WITH [CH] DIAL OR NUMBER KEY.

RxG:00.0% BE DISPLAY RX SIGNAL & POWER VOLTAGE(24V) WITH SETTING AT THE RECEIVING THAT BE DISPLAY END CURRENT & ANTENNA CURRENT WITH SETTING AT THE TRANSMITTING

ATT

AFTER [ATT] IS INVERTED USING ARROW KEY, PRESS [ENTER] Key.
PRESS ONCE, [1] IS CHANGED AND THEN ONE ATTENUATION IS ACTIVATED
PRESS TWICE, [2] IS CHANGED AND THEN TWO ATTENUATION IS ACTIVATED

AC

Be display to change to DC when turn off AC POWER.

N.B

AFTER [N.B] IS INVERTED USING [FNC] + [7] KEY, PRESS [ENTER] Key AND THEN ON/OFF

AGC

ADJUST INPUT SIGNAL AUTOMATICALLY, AFTER [AGC] IS INVERTED USING [FNC] + [8] KEY, PRESS [ENTER] Key AND THEN ON/OFF.

SQL

AFTER [SQL] IS INVERTED USING [FNC] + [9] KEY, PRESS [ENTER] Key AND THEN ON/OFF. (When setting up :)

2002. 4. 6

N 35.05 E 129.03

: GPS DATA SIGNAL (Lat. · Lot.)
While changing channels, indicate tuning condition

4.3 LEVEL OF LCD DISPLAY

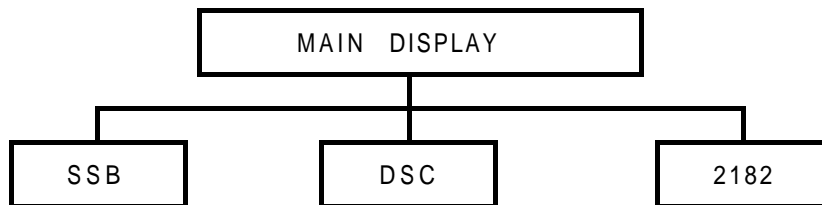

SSB

MAIN MENU

1. Scan Type Set
2. Scan Channel Set
3. Scan Frequency Set
4. SQL Set
5. LCD Contrast Set
6. TX POWER HIGH
7. Manual Tuning
8. ATU - VERSION
9. SYSTEM SET

DSC

MAIN MENU

1. Distress msg edit
2. Individual msg edit
3. Group msg edit
4. All ship msg edit
5. Geography msg edit
6. Auto / Semi - AT msg edit
7. Dist. ack/rly msg edit
8. Ordinary ack msg edit
9. Display & Send msg
0. System SET

2182

MAIN MENU

5. SSB RADIO TELEPHONE MODE

5.1 SELECT SSB MODE

(1) Select by [SSB] KEY

If pressing [SSB] KEY of FRONT PANEL, set to SSB MODE as follows.

4207			ACK=O	AC	H	15:00
<input type="checkbox"/>	CH	2	SSB			
<input type="checkbox"/>	TX	2,027.00				
<input type="checkbox"/>	RX	2,027.00				
RxG : 00.0%						
<input type="checkbox"/>	ATT	<input type="checkbox"/>	N.B	<input type="checkbox"/>	AGC	<input type="checkbox"/>
1999.05.22						

5.2 SSB MENU DISPLAY

* If pressing [MENU] KEY at SSB mode display, menu display is indicated as follows.

2187			ACK=O	AC	H	15:30
<input type="checkbox"/>	1. SCAN Type Ch					
<input type="checkbox"/>	2. SCAN CH. Set					
<input type="checkbox"/>	3. SCAN Freq Set					
<input type="checkbox"/>	4. SQL Set					
<input type="checkbox"/>	5. LCD Contrast 4					
<input type="checkbox"/>	6. Tx Power High					
<input type="checkbox"/>	7. Manual Tuning					
<input type="checkbox"/>	8. ATU - - - Version					
1	9. SYSTEM SET . .					

(1) SCAN TYPE SET

- a) Decide Scanning Channel or Frequency
- b) After [1.Scan Type Set] is inverted using [][] KEY, press [ENTER] KEY and then display is indicated
- c) In this mode, selected Scan Type is fixed.
 - ex) In case of Scan Type is ch. - Scan channel
 - In case of Freq. - Scan Freq.
- d) Press [CLR] key, changed to main display.

(2) SCAN CHANNEL SET

- a) Fix setting value in case of scanning Channel.
- b) After [2.Scan Channel Set] is inverted using [][] KEY, press [ENTER] KEY and then display is indicated.

Start	:	001	-	-
Last	:	299		
Speed	:	0		

- c) After moving cursor using [][][] KEY, set value using figure key and then press [ENTER] KEY
- d) [Start] : Set starting channel of Scan Channel.
[Last] : Set last Scan Channel.
[Speed] :Set Scan Channel Speed

(3) SCAN FREQUENCY SET

- a) Set setting value in case of scanning FREQUENCY
- b) After [3.Scan Frequency Set] is converted using [][] KEY, press [ENTER] KEY and then following display is indicated.

Start	:	00.500.0	-	-
Last	:	29,999,9	KHz	
Speed	:	0		
Step	:	001(100Hz)		

- c) After moving cursor using [][][] KEY, set value using figure key and press [ENTER] KEY
- d) [Start] : Set starting frequency of Scan Frequency.
[Last] : Set last frequency of Scan Frequency.
[Speed] : Set Scan Frequency Speed.
[Step] : Set Scanning frequency STEP(100HZ per 1Step)
ex) When '100' - 10KHz STEP

(4) SQL SET

- a) On standby, if set setting value of SSB particular sound clearance highly, cannot receive slight signal.
- b) If [4.SQL SET] is inverted using [][] KEY, following display is indicated.

SQL Sense : 01	Setting range : 01 ~ 20
SQL Delay : 01	Setting range : 01 ~ 20

- c) After moving cursor using [][][] KEY, set value using figure key and then press [ENTER] KEY
- d) [SQL Sense] : set setting value of squelch sensibility.
[SQL Delay] : set Delay time of squelch circuit.
- e) Press [CLR] key, changed to main display.

(5) LCD Contrast Set

- a) Adjust LCD light and divided from [0] to [7], the higher setting value, the darker
- b) After move to [5.LCD Contrast Set] using [][] KEY, press [ENTER] KEY and following display happens and then LCD light is changed.
- * [FNC] or [LIGHT] is able to be used also.

(6) TX Power Set

- a) Adjust TX output
- b) After [7.Tx Power Set] is inverted using [][] KEY, press [ENTER] KEY and then it will be reverted to High/Mid/Low in order.

(7) MANUAL TUNING

- a) When turning manually, menu is used.
- b) After [8.Manual Tuning] is inverted using [][] KEY, press [ENTER] KEY and then display as follows.

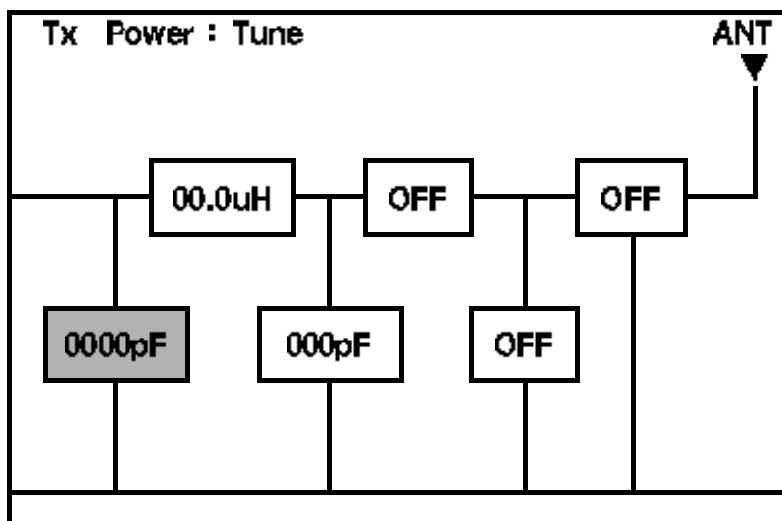

- c) Positioned adjustable element using [] [] KEY.
- d) After adjusting value using [] [] KEY, press [ENTER] KEY
- * If pressing [CLR] KEY, cancel adjusted value and return to first display.

(8) ATU - - - Version

- a) Indicate ATU version

(9) SYSTEM SET

- a) Decide SYSTEM setting value.
- b) If moving [0.SYSTEM SET...] using [] [] KEY, press [ENTER] KEY and display as follows

1. Tuning	Clear
2. SSB-CH	Clear
3. Date	Set
4. Time	Set
5. Key Tone	On
6. ADC Value	ANT
7. Auto	Tune
8. Self	Test

[1. Tuning Clear] : Clear all the memory tuned.

Revert [1. Tuning Clear] using [], [] key, press [ENT] key and display as follows.

Yes	No
------------	-----------

If select Yes, system is rebooting.

[2. SSB-CH Clear] : Delete SSB channel data and set basic channel.

Revert [2. SSB-CH Clear] using [], [] key, press [ENT] key and display as follows.

Yes	No
------------	-----------

If select Yes, system is rebooting.

[3. Data-Set] : Set the date displayed on system.

[4. Time-Set] : Set the time displayed on system.

[5. Key Tone] : Press [ENT] - tone ON/OFF

[6. ADC Value] : RxG in first display - Show selecting ON/OFF

Select ANT, 24V, SWR, IC.

RxG(RX signal level), ANT means (Antenna Current),

24V(Power Voltage), SWR(Reflected Wave Current),

IC(End Current). ANT, SWR, IC is indicated at TX

[7.Auto Tune] : Match all channels automatically.

Press [ENT], display as follows for each frequency by turns.

Freq	: 2,032.0khz
Tune	: Tuning - - -

[8.Self Test] : Self test function. Press [ENT], display as follows.

Version	: 2.0
Receiver	: good
Watch-R	: good
Exciter	: good
Tuner	: good

6. DIGITAL SELECTIVE CALLING(DSC) MODE

6.1 THE SELECTION OF DSC MODE

(1) selection by [DSC] key.

Press [DSC] key of the front panel, DSC MODE is set.

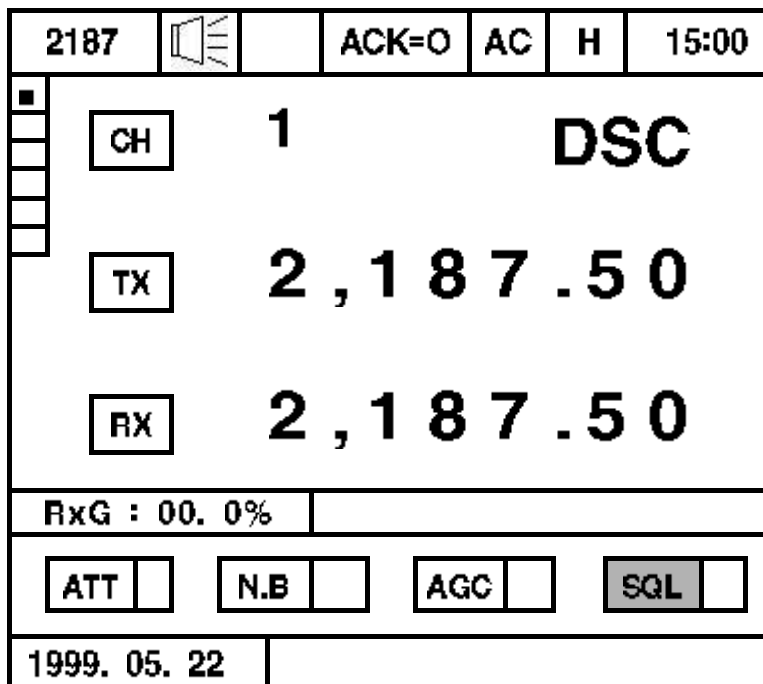

* CH1 ~ CH6 : In case of emergency only

* CH17 ~ CH19 : Can be used by user.

press [SCAN] key, scan only in specified data location within CH17 ~ CH19.

6.2 DSC MENU DISPLAY

Press the [MENU] KEY on the Initial screen of the DSC MODE, the sub menu screen is set as follows :

2187		ACK=O	AC	H	15:30
■	1. Distress msg edit				
□	2. Individual msg edit				
□	3. Group msg edit				
□	4. All ship msg edit				
□	5. Geography msg edit				
□	6. Auto/Semi - AT msg edit				
□	7. Dist ack/rly msg edit				
□	8. Ordinary ack msg edit				
□	9. Display & print msg				
1	0. SYSTEM SET				

(1) Distress msg edit

a) Use in a call of distress.

b) After converting [1.Distress msg edit] with [] [] key, press [ENTER] key and the screen is set as follows :

CH = 300	:	(NO DATA)
CH = 301	:	(NO DATA)
CH = 302	:	(NO DATA)
...	:	...
CH = 399	:	(NO DATA)

c) After selecting channel1 with [] [] [] key, press [ENTER] key and the message edit screen is set as follows.

FORMAT	:	Distress
NATURE	:	Undesignated
POSITION	:	N . E .
DIST-UTC	:	:
TEL CMD	:	J3E
EOS	:	EOS

[FORMAT] : Show a kind of call

Distress - Distress calling (Fixed)

[NATURE] : Set a type of distress

Fire, Explosion	Flooding
Collision	Grounding
Listing	Sinking
Adrift	Undesignated
Abandon ship	Piracy/Attack
Man Overboard	

[POSITION] : Set a position of distress.

Nxx.xx - North latitude (00.00 - 90.00)
Sxx.xx - South latitude (00.00 - 90.00)
Exxx.xx - East longitude (000.00 - 180.00)
Wxxx.xx - West longitude (000.00 - 180.00)

NOTE ! !) Do not out of the setting limit.

[DIST-UTC] : Set the time of distress

xx.xx - Time of distress (00:00 - 23:59)

Be set Automatically with the Input of GPS

[TEL CMD] : Set telecommand.

F3E/G3E Simplex
J3E
F1B/J2B Fec

[EOS] : Show the completion of DSC message.(End Of Sequence)

EOS - Be set automatically (Fixed)

d) Saving of the message

Press [1] , show [...File Saved...] and be saved.

(2) Individual msg edit

- a) Use in an individual call or ocean station call.
- b) After converting [2.Distress msg edit] with [] [] key, press [ENTER] key and the screen is set as follows :

```

CH = 300 : (NO DATA)
CH = 301 : (NO DATA)
CH = 302 : (NO DATA)
  ...
CH = 399 : (NO DATA)
  
```

- [][] : MOVE CHANNEL 1 BY 1 (UP/DOWN).
- [][] : MOVE CHANNEL 10 BY 10 (UP/DOWN).

- c) After selecting channel1 with [][][] key, press [ENTER] key and the message edit screen is set as follows ;

```

TX-Freq      : 2,187.5
FORMAT       : Individual
CATEGORY     : Routine
PARTY ID     : 000000000
TEL CMD 1    : J3E
TEL CMD 2    : No information
WORK FRQ     :
              08,200.0 / 08,200.0
EOS          : Ack RQ
  
```

[TX-Freq] : Indicate TX frequency.

```

01 : 2,187.5
02 : 4,207.5
03 : 6,312.0
04 : 8,414.5
05 : 12,577.0
06 : 16,804.5
19 : 8,414.5
  
```

Indicate the frequencies which is memorized by user in DSC mode CH7 ~ 19.

[FORMAT] : Indicate kind of call

Individual - a Individual call (Fixed)
--

[CATEGORY] : Set a purpose of call

Routine	Ship's business
Safety	Urgency
Distress	

[PARITY ID] : Input ID

[TEL CMD1] : Set Telecommand1

F3E/G3E simplex
F3E/G3E duplex
Polling
unable to comply
Data
J3E
H3E
F1B/J2B FEC
F1B/J2B ARQ
F1B/J2B receiver
Test
F1B/J2B
AIA morse
ship pos update
AIA morse
F1C/F2C/F3C
No information

Select J3E type of emission.

Select this menu when you want to know the position of the specific vessel.

[TEL CMD2] : Set Telecommand2

Telecommand is changed by [TEL CMD 1]

<J3E>

ship and aircraft
medical transport
pay phone call offices
No information

[WORK FRQ] : Set a operational frequency.
[EOS] : Show the completion of DSC message.
(Simpler form of 'End of Sequency)

ACK RQ	Calling for answer
EOS	End DSC message (End Of Frequency)

d) Function Key

Press [1], show [...File Saved...] and be saved.
Press [2], convert WORK, FRQ, MF/HF CH, VHF CH, POSITION.
When selecting PARTY ID, press [3], show ID list registered till then.

01 :	SY NO.1	77777777
02 :		11111111
03 :		
04 :		
~ :		
50 :		

While selecting WORK FRQ, press [3] then show the frequency list which is registered till then.

Tx Freq. Rx Freq.

01 :	10,000.0/20,000.0
02 :	14,000.0/14,000.0
03 :	/
04 :	/
50 :	/

(3) Group msg edit

a) Use in a group call

(Group - a ship in the same company or character.)

b) After operating [3.Group msg edit] with [] [] key, press [ENTER] key and the same screen is set as follows :

```
CH = 300 : (NO DATA)
CH = 301 : (NO DATA)
CH = 302 : (NO DATA)
...
CH = 399 : (NO DATA)
```

c) After selecting channel1 with [][][] key, press [ENTER] key and the message edit screen is set as follows :

```
TX-Freq      : 2,187.5
FORMAT       : Group
CATEGORY     : Routine
PARTY ID     : 000000000
TEL CMD 1    : J3E
TEL CMD 2    : No information
WORK FRQ     :
              8,3000.0 / 8,3000.0
EOS          : EOS
```

[TX-Freq] : Indicate TX frequency.

```
01 : 2,187.5
02 : 4,207.5
03 : 6,312.0
04 : 8,414.5
05 : 12,577.0
06 : 16,804.5
19 : 8,414.5
```

Moreover, indicate the frequency memorized by user in DSC MODE CH7 ~ CH19.

[FORMAT] : Show a kind of call.

```
GROUP - Showing a group call (Fixed)
```

[CATEGORY] : Set a purpose of call

Routine	Ship's business
Safety	Urgency
Distress	

[PARITY ID] : Input ID

[TEL CMD1] : Set telecommand

F3E/G3E simplex
F3E/G3E duplex
unable to comply
Data
J3E
H3E
F1B/J2B FEC
F1B/J2B ARQ
F1B/J2B receiver
F1B/J2B
AIA morse
AIA morse
F1C/F2C/F3C
No information

[TEL CMD2] : Sst telecommand2

Telecommand is changed by [TEL CMD 1].

<J3E>

ship and aircraft
medical transport
pay phone call offices
no information

[WORK FRQ] : Set a operational frequency.

[EOS] : Show the completion of DSC message (End Of Sequency)

EOS - Be set automatically (Fixed)

d) Function Key

Press [1] , show [...File Saved...] and be saved .

Press [2], convert WORK, FRQ, MF/HF CH, VHF CH, POSITION.

When selecting PARTY ID, press [3], show ID list registered till then.

01 :	SY NO.1	????????
02 :		11111111
03 :		
04 :		
~ :		
50 :		

While selecting WORK FRQ, press [3] then show the frequency list which is registered till then

	Tx Freq.	Rx Freq.
	↓	↓
01 :	10,000.0	20,000.0
02 :	14,000.0	14,000.0
03 :	/	/
04 :	/	/
50 :	/	/

(4) All Ship msg edit

a) Use in all of the ships to call.

b) After converting [4.All ships msg edit] with [] [] key, press [ENTER] key and the screen is set as follows :

CH = 300	:	(NO DATA)
CH = 301	:	(NO DATA)
CH = 302	:	(NO DATA)
...	:	...
CH = 399	:	(NO DATA)

c) After selecting channel1 with [] [] [] KEY, press [ENTER] key and the message edit screen is set as follows :

TX-Freq	:	2,187.5
FORMAT	:	All ship
CATEGORY	:	Distress
TEL CMD 1	:	J3E
TEL CMD 2	:	No information
WORK FRQ	:	
	:	/
EOS	:	EOS

[TX-Freq] : Indicate TX frequency.

01	:	2,187.5
02	:	4,207.5
03	:	6,312.0
04	:	8,414.5
05	:	12,577.0
06	:	16,804.5
19	:	8,414.5

Indicate the frequencies memorized by user in DSC mode CH7~CH19.

[FORMAT] : Show a kind of a call.

ALL Ship - Showing all of the ships (Fixed)

[CATEGORY] : Set a purpose of call.

Safety	Urgency
Distress	

[TEL CMD1] : Set telecommand1

F3E/G3E simplex
F3E/G3E duplex
unable to comply
Data
J3E
H3E
F1B/J2B FEC
F1B/J2B ARQ
F1B/J2B receiver
F1B/J2B
AIA morse
AIA morse
F1C/F2C/F3C
No information

[TEL CMD2] : Set telecommand2

Telecommand is changed by [TEL CMD1].

<J3E>

ship and aircraft
medical transport
pay phone call offices
no information

[WORK FRQ] : Set a operational frequency.

[EOS] : Show the completion of DSC message.(End Of Sequency)

EOS - Be set automatically (Fixed)

d) Function Key

Press [1] , show [...File Saved...] and be saved .

Press [2], convert WORK, FRQ, MF/HF CH, VHF CH, POSITION by turns.

When selecting PARTY ID, press [3], show ID list registered till then.

01 : SY NO.1	TTTTTTTT
02 :	11111111
03 :	
04 :	
~ :	
50 :	

While selecting WORK FRQ, press [3] then show the frequency list which is registered till then.

	Tx Freq.	Rx Freq.
	↓	↓
01 :	10,000.0	/20,000.0
02 :	14,000.0	/14,000.0
03 :		/
04 :		/
50 :		/

(5) Geography msg edit

a) Use in a definite area.

b) After converting [5.Geography msg edit] with [] [] key, press [ENTER] key and the screen is set as follows :

CH = 300	: (NO DATA)
CH = 301	: (NO DATA)
CH = 302	: (NO DATA)
...	...
CH = 399	: (NO DATA)

c) After selecting channel1 with [][][] key, press [ENTER] key and the message edit screen is set as follows :

TX-Freq	:	2,187.5
FORMAT	:	Geography
CATEGORY	:	Routine
PARTY AD	:	N E DA DO
TEL CMD 1	:	J3E
TEL CMD 2	:	No information
WORK FRQ	:	
	:	/
EOS	:	EOS

[TX-Freq] : Indicate TX frequency.

01	:	2,187.5
02	:	4,207.5
03	:	6,312.0
04	:	8,414.5
05	:	12,577.0
06	:	16,804.5
19	:	8,414.5

Indicate the frequencies memorized by user in DSC mode CH7~CH19.

[FORMAT] : Show a kind of call.

Geography - Showing a areal call

[CATEGORY] : Set a purpose of call.

Routine	Ship's business
Safety	Urgency
Distress	

[PARITY AD] : Input a definite area.

Nxx - North latitude (00 - 90)
Sxx - South latitude (00 - 90)
Exx - East longitude (000 - 180)
Wxx - West longitude (000 - 180)
DA - A limit on latitude (the value of offset)
Do - A limit on longitude(the value of offset)

[TEL CMD1] : Set telecommand1.

F3E/G3E simplex
F3E/G3E duplex
unable to comply
Data
J3E
H3E
F1B/J2B FEC
F1B/J2B ARQ
F1B/J2B receiver
F1B/J2B
AIA morse
AIA morse
F1C/F2C/F3C
No information

[TEL CMD2] : Set telecommand2.

Telecommand is changed by [TEL CMD1].

<J3E>

ship and aircraft
medical transport
pay phone call offices
no information

[WORK FRQ] : Set a operational frequency.

[EOS] : Show the completion of DSC message. (End Of Sequency)

EOS - Be set automatically (Fixed)

d) Function Key

Press [1] , show [...File Saved...] and be saved .

Press [2], convert WORK, FRQ, MF/HF CH, VHF CH, POSITION by turns.

When selecting PARTY ID, press [3], show ID list registered till then.

01 : SY NO.1 ????????
02 : 11111111
03 :
04 :
~ :
50 :

While selecting WORK FRQ, press [3] then show the frequency list which is registered till then.

	Tx Freq.	Rx Freq.
	↓	↓
01 : 10,000.0/20,000.0		
02 : 14,000.0/14,000.0		
03 : /		
04 : /		
50 : /		

(6) Auto/Semi-AT msg edit

a) Use to contact with an aerial communication net

b) After converting [6. Auto/Semi-AT msg edit] with [] [] key, press [ENTER] key and the same screen is set as follows :

CH = 300 : (NO DATA)
CH = 301 : (NO DATA)
CH = 302 : (NO DATA)
...
CH = 399 : (NO DATA)

c) After selecting channel with [][][][] key, press [ENTER] key and the message edit screen is set as follows :

TX-Freq	:	2,187.5
FORMAT	:	AT / semi - AT
CATEGORY	:	Routine
PARTY ID	:	00000000
TEL CMD 1	:	J3E
TEL CMD 2	:	No information
WORK FRQ	:	
	:	/
TEL NO	:	
EOS	:	Ack RQ

[TX-Freq] : Indicate TX frequency.

01	:	2,187.5
02	:	4,207.5
03	:	6,312.0
04	:	8,414.5
05	:	12,577.0
06	:	16,804.5
19	:	8,414.5

Indicate the frequencies memorized by user in DSC mode CH7~CH19.

[FORMAT] : Show a kind of a call.

AT/semi-AT - Showing AT/semi-AT calling (Fixed)

[CATEGORY] : Set a purpose of call.

Routine - A usage (Fixed)

[PARTY ID] : Input ID

[TEL CMD1] : Set telecommand 1

F3E/G3E simplex
F3E/G3E duplex
unable to comply
Data
J3E
H3E
F1B/J2B FEC
F1B/J2B ARQ
F1B/J2B receiver
F1B/J2B
AIA morse
AIA morse
F1C/F2C/F3C
No information

[TEL CMD2] : Set telecommand 2

Telecommand is changed by [TEL CMD1].

<J3E>

ship and aircraft
medical transport
pay phone call offices
no information

[WORK FRQ] : Set a operational frequency.

[TEL NO] : Input a telephone number.

[EOS] : Show the completion of DSC message.(End Of Sequency)

ACK RQ - BE SELECTED .(ESTABLISHED)

d) Function Key

Press [1] , show [...File Saved...] and be saved .

Press [2], convert WORK, FRQ, MF/HF CH, VHF CH, POSITION by turns.

When selecting PARTY ID, press [3], show ID list registered till then.

01 : SY NO.1	TTTTTTTT
02 :	11111111
03 :	
04 :	
~ :	
50 :	

While selecting WORK FRQ, press [3] then show the frequency list which is registered till then.

	Tx Freq.	Rx Freq.
	↓	↓
01 :	10,000.0/20,000.0	
02 :	14,000.0/14,000.0	
03 :	/	
04 :	/	
50 :	/	

(7) Dist ack/rly msg edit

- a) Can be use at distress answer or transmitting.
- b) When press [ENTER] KEY after to invert [7.Dist ack/rly msg edit] by [] [] KEY, be display as follows :

2187		ACK=0	AC	H	15:00
					ch. : 450
<pre> 99.10.21 14:05 , 6,312.0 FORMAT : Distress DIST-ID : 111111111 NATURE : undersignated POSITION : N. E DIST-UTC : TEL-CMD : F3E/G3E simplex EOS : EOS </pre>					
1.	2. Manual	3.			

Indicate list of CH 450 ~ CH 499

- c) Press [2], display as follows.

TX-Freq	: 2,187.5
FORMAT	: All ship
CATEGORY	: Distress
PARTY ID	: 000000000
TEL CMD	: Distress Relay
PARTY AD	: N E DA DO
DIST-ID	:
NATURE	: undersignated
POSITION	: N . E .
DIST-UTC	:
TEL CMD	: F3E/G3E Simplex
EOS	: Ack RQ

In case there is other vessel in distress or it's not able to send distress signal, this function can be used instead of 'Distress Signal' by pressing [CALL].

[TX-Freq] : Indicate TX frequency.

01 : 2,187.5
02 : 4,207.5
03 : 6,312.0
04 : 8,414.5
05 : 12,577.0
06 : 16,804.5

Indicate the frequencies memorized by user in DSC mode CH7 ~ CH19.

[FORMAT] : Show a kind of a call.

Geography
Group
All ship
Individual

[CATEGORY] : Set a purpose of call.

Distress - (Fixed)

[PARITY ID] : Input ID. (Geography, in case of all ship - x)

[TEL CMD] : Selet telecommand. (In case of all ship -)

Distress AcK
Distress Relay

In case let know the receiving the distress signal.
In case of relaying broadcast cause the distance is far from shore station.

[PARTY AD] : Input specific area.(Group, All ship individual - x)

[DIST-ID] : Input the ID of the vessel in distress.

[NATURE] : Set the type of Distress.

Fire, Explosion	Flooding
Collision	Grounding
Listing	Sinking
Adrift	Undesignated
Abandon ship	Piracy/Attack
Man Overboard	

[POSITION] : Explain the position of distress.

Nxx - North latitude (00.00 - 90.00)
Sxx - South latitude (00.00 - 90.00)
Exx - East longitude (000.00 - 180.00)
Wxx - West longitude (000.00 - 180.00)

[DIST-UTC] : Set the time of distress happened.

xx : xx - Distress Time(00:00 - 23:59)

[TEL CMD] : Set telecommand.

F3E/G3E Simplex
J3E
F1B/J2B Fec

[EOS] : Show the completion of DSC message (End Of Sequence)

EOS - Be set automatically (Fixed)

(8) Ordinary ack msg edit

- a) Can be use to common answer call.
- b) When press [ENTER] KEY after to invert [8.Ordinary ack msg edit] by [] [] KEY, be display as follows :

2187		ACK=O	AC	H	15:00
.					ch. : 400
	99.10.21 16:13 , 8,414.5				
	FORMAT : Individual				
	CATEGORY : Routine				
	PARTY-ID : 111111111				
	TEL CMD1 : J3E				
	TEL CMD2 : No information				
	WORK FRQ :				
	8,200.0 / 8,200.0				
	EOS : ACK BQ				
1.	2.	3.			

Display CH400 ~ CH499.

- c) [] [] - Move channel 1 by 1 (up/down)
[] [] - Move channel 10 by 10 (up/down)
- d) Able to answer pressing [CALL] key.

(9) Display & Print msg

- a) Can be use at checking written Message or printing.
- b) When press [ENTER] KEY after to invert [9.Display & Send msg] by [] [] KEY, be display as follows screen.

2187		ACK=0	AC	H	15:00
.					ch. : 300
.	99.10.19 16:27 FORMAT : Group CATEGORY : Routine PARTY -ID : 111111111 TEL CMD1 : J3E TEL CMD2 : No information WORK FRQ : <div style="text-align: right; padding-right: 50px;">8,200.0 / 8,200.0</div> EOS : ACK RQ				
1.	2.	3.			

- c) [] [] - Move channel 1 by 1 (up/down)
- [] [] - Move channel 10 by 10 (up/down)

(10) SYSTEM SET

- a) Decide the setting value manu of SYSTEM.
- b) Move cursor to [0.SYSTEM SET...] with [] [] KEY and press [ENT] key be display as following screen ;

Self - ID Set	123456789
Group - ID Set	011111111
Dist TEL - CMD	J3E
LAT / LON Set	
ID/FR/TEL Set	
WKR Scan Set	
Data Clear	
ID Printing	
Data Transmit	
Dsc - Etc Set	

Then if you press [CNR] key, display as follows.

000000000

(Blank No. will be filled with 0)

If you input "SY ENC", display as follows.

```
01 : SY ENC   101010000
02 :
03 :
04 :
~ :
50 :
```

It can be done in [ID EDIT] only.

[WKR Scan Set] : Scanning W/K frequency ON/OFF

```
2187.5 on
4207.5 on
6312.0 off
8414.5 on
12577.5 off
16804.5 off
```

Using [] [] keys it can be ON/OFF with pressing [ENT] on the frequency which you want.

But, it is impossible to make [2187.5] and [8414.5] off.

[Data Clear] : Delete the written data by user and received data.

```
DSC Made-File clear
DSC Distress clear
DSC Ordinary clear
```

Maden DSC Data by user
Distress data in the received DSC data
Data expect Distress data in the received data

Using [] [] keys, after reverting the spot you want press [ENT], then it shows as follows.

```
Yes   No
```

[ID printing] : Print ID

[Data Transmit] : Select kind of data transmitting.

Dot Transmit	Send Dot signal only
Mark transmit	Send Mark signal
Space Transmit	Send Space signal

[DSC-Etc Set] : Set ETC. system

Gps-Alarm Set off
Scan Speed Set
Default Channel
Auto-ACK Set Off
Dist-Key Test

GPS-Alarm Set - Press [ENT] key, ON/OFF

While 'on', if GPS signal is not receiving alarm rings every 1 min.

SCAN Speed Set - Adjust SCAN Speed of usable DSC channel by user.

The higher number it is, the slower speed.

Range is 0 ~ 9.

Default Channel - Adjust Tx-Freq in DSC menu.

Select the frequency you want.

2,187.5
4,207.5
6,312.0
8,414.5
12,577.0
16,804.5

Auto-ACK Set off - Press [ENT], ON/OFF

ON : ACK=O

OFF : ACK=X

Dist-Key Test - Test [Distress] key

If it works properly,

Press Distress Key display

If press [Distress] key for 3 sec.

Press Stop Key display and if press [STOP],

Ok. (Press any Key) display.

7. TRANSMITTER OF DISTRESS SIGNAL

7.1 TEST OF DISTRESS ALERT SIGNAL

a) When press [2182] key of Front PANEL, be display as follows :

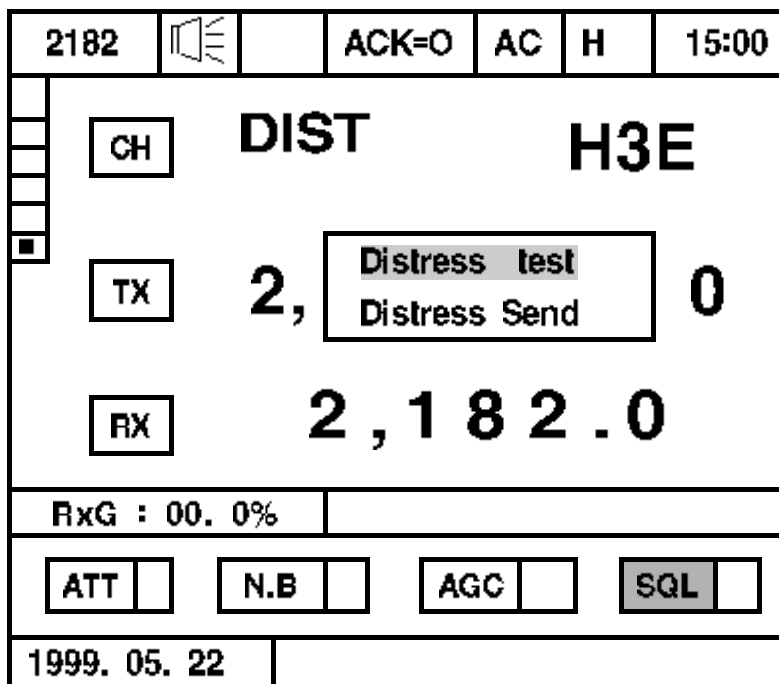

b) Only transmitting is not working in this mode.

c) If you want to make test stop, press [STOP].

7.2 TRANSMITTER OF DISTRESS ALERT SIGNAL

- a) When press [2182] key of Front PANEL, be display as following screen.
 After revert [DISTRESS SEND] key, transmit distress signal pressing [ENT].

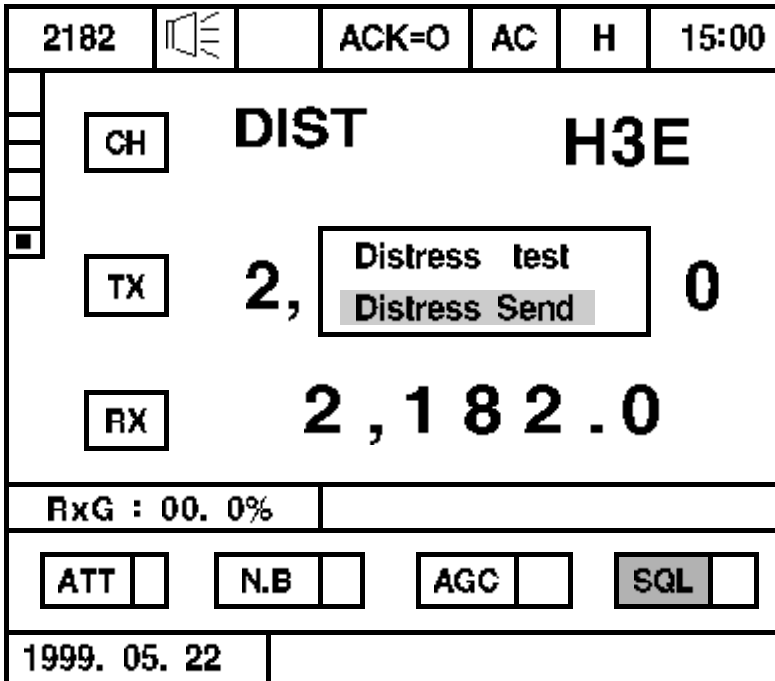

- b) If you want to make TX stop, press [STOP].
- c) Revert to SSB mode pressing [SSB], CHANNEL dial, [SSB] key.

7.3 HOW TO SEND AND OPERATE DIGITAL DISTRESS SIGNAL

- a) Press [Distress Send] button for 3 sec. on front panel, will be showed as follow screen. Then "Distress" LED blink that means the position, time, ship ID will be sent.

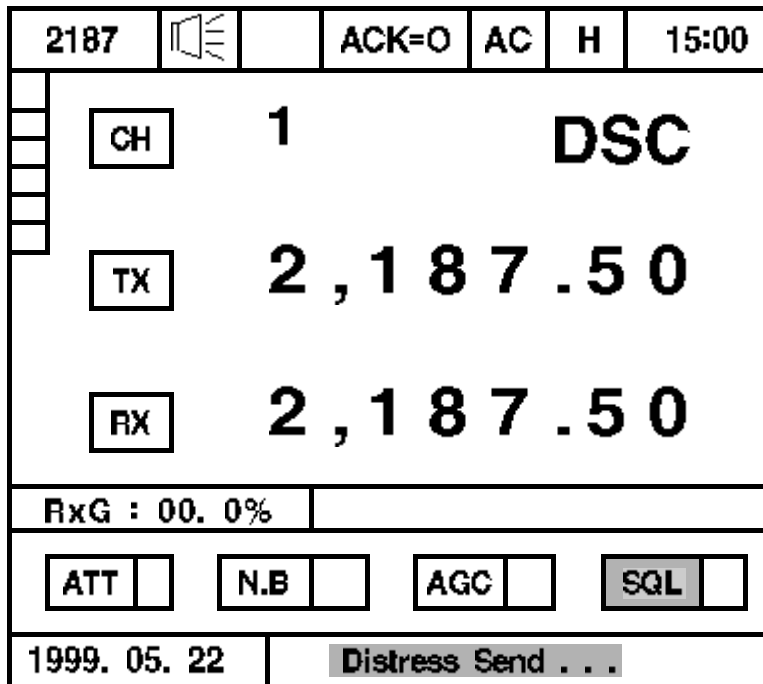

Receiving channel range is from 1 to 6 as follows.

01	: 2,187.5
02	: 4,207.5
03	: 6,312.0
04	: 8,414.5
05	: 12,577.0
06	: 16,804.5

8. HOW TO USE PRINTER

8.1 DPU-414 PRINTER

(1) Caution when use printer

a) The printing paper used for the DPU-414 is a special kind of paper which turns black by the thermochemistry reaction. Take as following precaution when using the paper.

- Store away from Hit, humidity, light
- Dry your hands before handling the paper.
- Do not rub the paper with any kind of hard or coarse materials.
- Do not use organic adhesive on the paper. (Instead of that, water-based starch adhesives or compound adhesive.)
- Do not use adhesive tape on the paper. (However, using both sided tape is possible.)
- Do not allow the paper to remain in contact with polyvinyl chloride film for a long time.
- Do not leave the paper in contact with freshly coped giazio type or wet process paper.
- Do not allow the paper to come into contact with organic solvents.

b) Caution when operate printer

- Check there is a paper in it before use.
- Do not turn off while operation and turn off after PRINT HEAD is at HOME POSITION.
- Printer test function is built-in.

(2) Operation Panels

a) Power switch

: Switch on the turn this unit on. Printer head do going and returning once, the paper is fed by one column.

On condition that main unit of SRG-1150DN/SRG-1250DN is power on.

b) FEED switch

: Press FEED switch when feed the paper out by force.

On pressing this switch once, it will be feed once and on pressing this switch continuously, it will be kept feeding.

c) Cutter : Use for cutting the printer paper.

d) Exit of paper : it is the part where the paper is ejected through it.

e) Paper cover : Store up the paper inside it.

(3) Usual operation

Check the main unit of SRG-1150DN/SRG-1250DN is turned on.
If power on, it is able to print TX/RX DSC MESSAGE and DATA from SRG-1150DN/SRG1250DN automatically.

(4) How to store the printer paper roll

a) Cut the printer paper horizontally.

If there is the wrinkle on the paper, it may cause the paper jam.

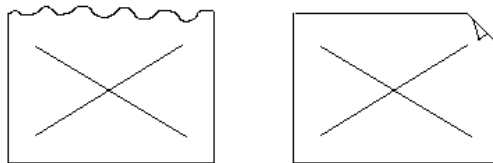
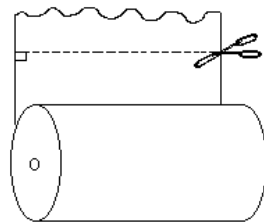

PRINTER PAPER HANDLING

b) Switch off the printer.

c) Open the PAPER COVER and pull out the center shaft.

d) Insert the center shaft in the center of the PAPER ROLL and put the end of the paper into the way-in of the paper.

e) Switch of the PRINTER and press the FEED KEY until the paper is hauled.

f) Store up the center shaft and the paper gets out of the way-out.

g) Press FEED KEY until the end of paper gets out of the way-out.

h) Close the PAPER COVER and put it down to shut.

8.2 OKI PRINTER

(1) IMPORTANT

a) The wires this mains lead are coloured in accordance with the following code:

GREEN AND YELLOW	EARTH
BLUE	NEUTRAL
BROWN	LIVE

As the colors of the wires in the main lead of this apparatus may not correspond with the coloured markings identifying the terminals in your plug PROCEED AS FOLLOWS:

The wire coloured GREEN AND YELLOW must be connected to the terminal in the plug marked with the letter E or by the safety earth symbol or coloured GREEN or GREEN AND YELLOW. The wire coloured BROWN must be connected to the terminal marked with the letter L or coloured RED. The wire coloured BLUE must be connected to the terminal marked with the letter N or coloured BLACK.

WARNING : THIS APPARATUS MUST BE EARTHED

b) Ensure that your equipment is connected correctly.

If you are in any doubt consult a qualified electrician. Operating your Printer. Buttons, Levers and Indicators.

Before using your printer, it is worth familiarizing yourself with the buttons, levers and indicators on the printer and to understand the various methods of loading paper.

The front panel of the printer has six buttons. Also there are indicator lights that show the status of the printer, mode and pitch selected.

c) POWER Indicator : Indicates that the printer power is turned ON.

d) SELECT Button

: Pressing this button after the printer power is On places the printer in deselect mode the computer cannot communicate with the printer.

To return to select mode, simply press this button again.

Pressing this button also stops the self test. It is also used to enter into HEX-dump mode: turn the printer ON while holding down the SELECT and FORM FEED buttons.

Hex mode generates data rather than test and a sample is shown below.

To terminate this mode, switch the printer off and on again.

Switching on the printer while holding down th SELECT and Line Feed buttons will generate a rolling ASCII character display, Reset the printer to terminate.
A sample is shown below.

e) TOF button

: To set the first position on each page (Top of Form), deselect the printer when the print head is in the desired position.

You can also select 17.1 character per inch printing by holding this button down when turning printer power ON.

f) SELECT Indicator

: Works together with the SELECT button. Lights when the printer is selected (ready to receive data from the computer).

The indicator is not lit when th printer is deselected or during self tests.

If an abnormal status is detected during the self test the indicator flashes.

g) FORM FEED Button

: To advance the paper to the nest page (Top Of Form), press this button while the printer is deselected.

You can also select NLQ (Near Letter Quality) with this button. Just hold down the FORM FEED button while switching on the printer.

h) ALARM Indicator

: Lights when paper supply is low or exhausted (unless you use the command to disable the alarm). Printing stops until the paper supply is replenished.

It is also lit when a jam is detected using th CSF. The light flashes when high temperatures are detected in th print head and space motor.

Allow th printer to cool down before re-using.

i) LINE FEED Button

: If you want to advance the paper one line, press this button while the printer is deselected. A DEMO page print can be generated by switching on the printer and holding down the Line Feed Button. This print out illustrates the various styles of printing available from the ML184Turbo.

Once printed, the printer automatically reverts to 10cpi Utility mode.

An example of the DEMO PAGE IS ON THE NEXT PAGE.

j) PITCH Button

: This button allows you to manually select the character pitch.

The appropriate lamp glows upon selection. The lamps also light as software changes, for example, normal to condensed, are implemented.

k) MODE Button

: Similar function to above, but this refers to the print quality selected:

NLQ, Utility or High Speed Draft. The levers on the printer allow you to adjust the paper.

l) PAPER LOCK / RELEASE LEVER

: Open (slide forwards) for inserting paper, and adjusting paper, and when using tractor fed computer paper. Close (slide back) for use with roll paper and for single sheets.

m) PAPER GAP ADJUSTMENT

: Slide towards the back of the printer when inserting single sheets, and away when using multi-part paper.

(2) PAPER LOADING

Bottom Feed Paper Loading

a) Place the printer on a slotted printer stand, carefully aligning the slot in the stand with the opening in the base of the printer.

b) Place the box of paper under the printer stand.

c) remove the access cover and lift the column indicator bar.

d) Open the paper release lever.

e) Insert the first sheet of paper through the opening in the bottom of the printer.

f) Slide the paper up until it appears in front of the platen.

g) Lower the column indicator bar.

h) Close the paper release lever.

i) Use the platen knob to advance the paper to the first printing line.

j) Replace the access cover.

Rear Fed Paper Loading

a) Put the printer on a desk or table.

b) Place the box of paper behind the printer.

c) Remove the access cover and lift the column indicator bar.

d) Open the paper release lever.

e) Insert the first sheet of paper in the paper guides.

- f) Push the paper in just enough so that its sprocket holes engage the sprocket pins located on the platen ends.
- g) Turn the platen knob to advance the paper until it appears in front of the platen.
- h) Lower the column indicator bar.
- l) Close the paper release lever.
- j) Use the platen knob to advance the paper to the first printing line.
- k) Replace the access cover.

9. HOW TO USE SD-250(ALARM BOX)

9.1 DISTRESS TRANSMITTING

1. If you press 'Distress Key'(red button) for 3 sec., it alarm for 3 sec.
After that, the red light is turned on with bip- sound.
While Distress Key is blinking, transmitting is started to work and location of disaster, time, ship's ID are sent to DSC 6CH in order.
If there is no answer, it do sending till getting an answer through CH1 to CH6.
2. If you make transmitting stop, press 'Reset key'.
If distress signal is sent by mistakes, contact to marine police or station, SAR.

9.2 IN CASE OF RECEIVING DISTRESS SIGNAL

1. Distress LED blinks and sounds 'bip'.
Check contents displayed on the screen and press Reset key to stop.

9.3 OPERATION BY DC POWER (BATTERY)

1. If AC power is turned off, POWER LED will started blinking with "bip-" sound.
When bip is stoped, press Reset Key.
2. POWER LED keep blinking while the equipment is operated by DC power.

10. EXPLANATION OF CIRCUIT

10.1 OVERVIEW OF SRG-1150DN/SRG-1250DN

1. SRG-1150DN MF/HF DSC RADIO EQUIPMENT consists of circuit, NBDP terminal(SN-100), PRINTER, ATU(SAT-100) as follows.

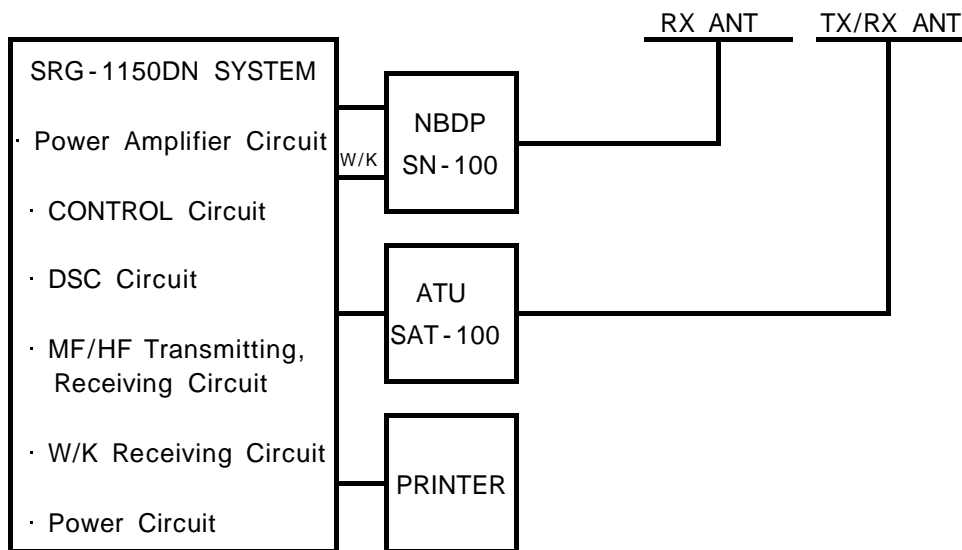

SRG-1150DN BLOCK DIAGRAM

2. SRG-1250DN MF/HF RADIO EQUIPMENT consists of circuit , NBDP(SN-100) TERMINAL, RF AMPLIFIER, PRINTER and ATU(SAT-100).

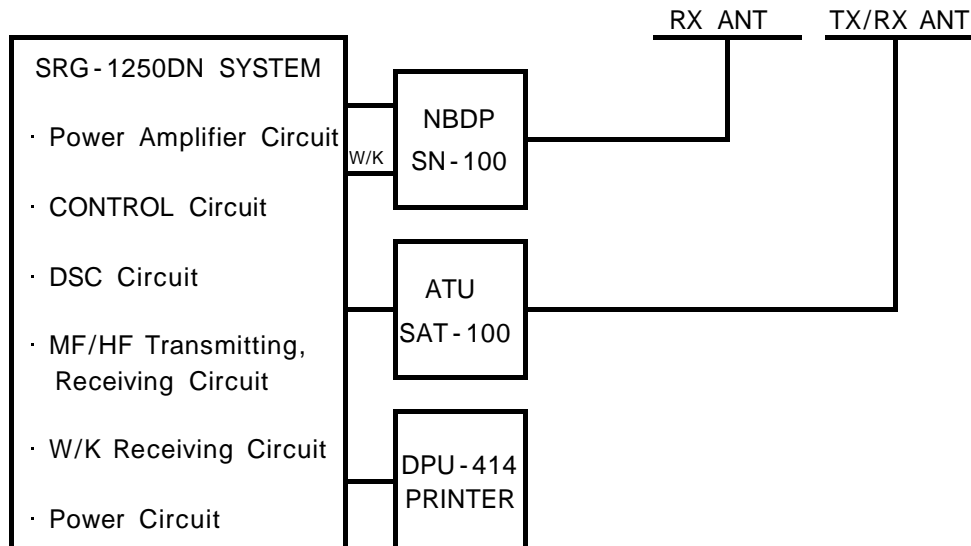

SRG-1250DN BLOCK DIAGRAM

SRG-1250DN consists of DSC circuit, control circuit, MF/HF receiving circuit, W/K receiving circuit, MOTHER BOARD and power circuit.

At the bottom of this equipment's rear side, there are aerial coaxial connector for MF/HF transceiver, coaxial connector for W/K receiver, connector for print connecting, SPK JACK or BK Connecting terminal, ATU connecting CONNECTOR or earth terminal for system earthing.

10.2 POWER CIRCUIT

Power circuit consists of control circuit of power unit to turn on/off DC-24V in power amplify unit, constant voltage circuit to supply DC voltage to be constant voltage in each unit, AUDIO AMP for external speaker and operate through DC INPUT(24V BATTERY).

Main power circuit and power control circuit SWITCH ON main power DC 24V when turn on and convert constant voltage to +15v, +12v . EXT. supply power even in AMP of speaker and SN-100 TERMINAL.

(if NBDP TERMINAL is set.)

PROTECTION and ALARM

In overload voltage +32v, make power off and built circuit to prevent conversing voltage not to damage equipment even in conversing voltage.

10.3 TRANSMITTING CIRCUIT

Bias voltage operate and maintain fitting voltage to press PTT(transmitting switch) installed in HAND MIC and virus voltage even in output amp for excitation is supplied and receive sound-input from MIC installed and after amplify audio-input in AF

AMP(T-452 Q34, Q36), in BALANCE MODULATION, mixed with BFO and in SSB FILTER(XL2) filter low frequency part.

So, this signal is mixed in 49MHZ LOCAL and IC3 and amplify in 49MHZ+IF=2'nd IF AMP(Q29).

This signal pass 49.455MHZ FILTER and is mixed in $F_c+49.455\text{MHZ}$ LOCAL and IC4 is amplify in RF AMP(Q31,Q32) and pass LOW PASS FILTER.

This signal go to external RF AMPLIFIER and pass TX FILTER(T-551) and go to POWER SPLITTER(T-516_1) and pass T1,T2 and is separated as PWR AMP A(T-514) and PWR AMP B(T-514).

This signal go to TX PWR CONBINER(T-516_2) and is combined and after go to DSC TX FILTER(T-517) and amplify, in the selected TX LOW PASS FILTER, remove spurious and pass antenna terminal and go to ATU and match transmitting frequency and antenna frequency and transmit through antenna.

10.4 MF/HF RECEIVING CIRCUIT

Receiving signal in whip antenna pass band filter and after filter, amplify in ultrashort amplifier T-454(Q13, Q14) and in 1 st MIXER, $f_c+49.455\text{MHZ}$ LOCAL and BALANCE MIXER and make IF 49.455MHZ.

This signal pass 455MHZ FILTER to become filtering and in amplifier Q9, amplify and be balance mixed in 2 hd LOCAL 49MHZ and 2 hd MIXER Q7, Q8 and make 455KHZ IF.

This signal become filtering through J3E(XL2), H3E(XL1) FILTER according to MODE.

Again, amplify in Q1,IC6 and mix SSB and H3E in IC7.

Mixed signal is divided to 3 species as follows.

amplify for inner speaker audio.

amplify for outer speaker audio.

FSK MODEM (DSC signal mix)

10.5 MOTHER BOARD(T-570)

Function of Mother Board (T-570) is connecting PCB

- T-451(SRG-1150DN TX FILTER)/ T-461(SRG-1250DN TX FILTER),
 - T-454(TX/RX EXCITER),
 - T-557(CONTROL), T-553(PLL SYNTHESIZE),
 - T-555(POWER SUPPLY UNIT),
 - T-552(W/K RECEIVER),
 - T-514(SRG-1150DN TX POWER AMP)/T-524(SRG-1250DN TX POWER AMP)
- each other.

BK signal given from external pass PHOTO COUPLER to separate union earthing POLE from receiver inner circuit and supply in BK control circuit.

BK controlling circuit control BK RELAY of input unit of high frequency and AGC circuit and protect receiver from over input.

Simultaneously, have a muting receiving circuit.

Moreover, it connect several connectors at rear side and do switching power supply of RX and TX.

- a) This circuit board incorporate through most circuit board to consist of main unit organically and electronically and operate.
- b) In this circuit board, connecting of front, rear and external is carried on and each connector pass filter circuit for noise-clear and is connected
- c) Each circuit board connected by this circuit board arranged connectors mechanically not to incorporate in wrong-position.

SCHEMATIC IS AS FOLLOW.

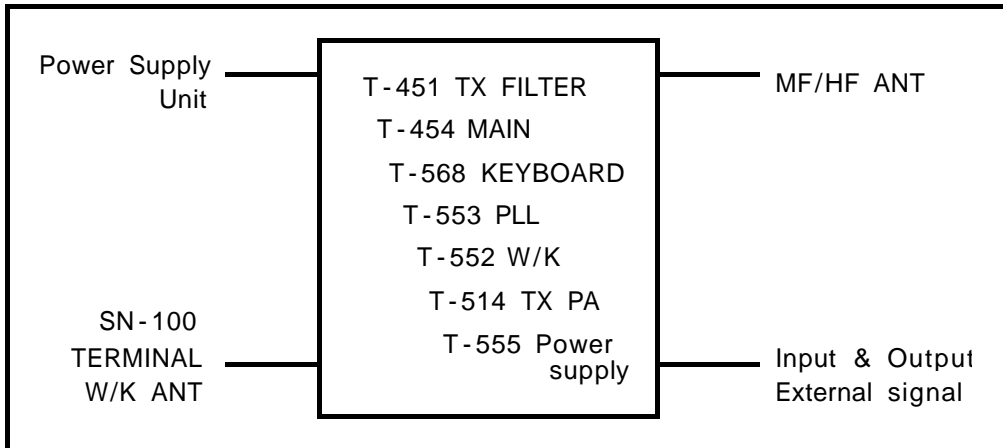

SRG-1150DN

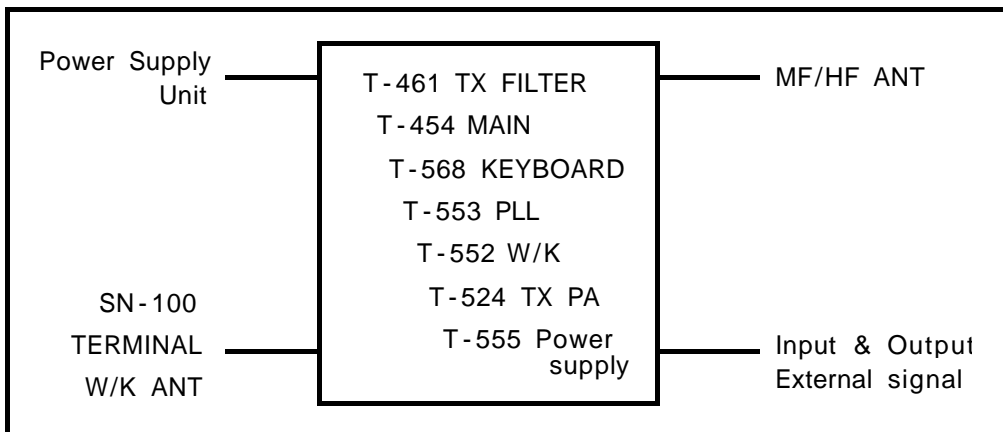

SRG-1250DN

10.6 TX FILTER(SRG-1150DN : T-451, SRG-1250DN : T-461)

If TX+ 12V signal is not showed in the PCB circuit, the main PCB(T-454) and antenna are connected any time. And if Tx+ signal is showed, antenna is connected sith TX POWER(SRG-1150DN : T-514, SRG-1250DN : T-524) through FILTER circuit.

At this time, a filter is selected by transmitting frequency.

10.7 SYNTHESIZER (T-553)

This circuit of PCB is divided to two part (MF/HF unit and W/K SYNTHESIZER) as SRG-1150DN/SRG-1250DN FREQUENCY SYNTHESIZER.

MF/HF unit SYNTHESIZER

PLL(IC8) and VCO(2MVCO) is output as MF/HF 1 st LOCAL input signal (49.455MHZ ~ 79.4549MHZ) and 7MHz from OUTPUT of DDS3 makes 49MHZ in 7

frequency multiplier circuit(T7, 9, 11, 12) and use as 2nd LOCAL.
3rd LOCAL makes 456.4KHZ \pm 125HZ signal directly from DDSI.

W/K UNIT SYNTHESIZER

PLL(IC17)and VCO(VCO&) is output as MF/HF 1st LOCAL inputting signal (66.2595MHZ, 62.0120MHZ, 57.8695MHZ, 55.7670MHZ, 53.6625MHZ, 51.6425MHZ)
In output of DDS3, outputting 7 MHz make 49MHz in 7 frequency multiplier circuit(T8. 9. 11, 12) and use as 2nd LOCAL.

3rd LOCAL makes 456.7KHZ signal directly from DDS1.

10.8 POWER CONTROL (T-555)

Circuit of this PCB have main constant voltage (+12V) and vertical current CHECK circuit(IC2).

If PWR SW turn ON, relay do not operate until becoming 4.5V by IC7, this signal make TX CURRENT happen through BiMOS Operational Amplifiers(IC3), AUDIO signal(CONNECTOR 6PIN, 5PIN) connect PHONE JACK through amplifier(IC6).

10.9 PA AMP(SRG-1150DN : T-514, SRG-1250DN : T-524)

This PCB circuit consists of TX output POWER AMP, TX output is 150W(SRG-1150DN) and 250W(SRG-1250DN).

10.10 CONTROL (T-557)

This PCB circuit consists of CPU(IC1), MEMORY ROM(IC2)/RAM(IC3), CLOCK GENERATOR(IC4), BUFFER(IC5), I/O AMPLIFY(IC17), AC/DC CONVERTER(IC15), RS-232C(IC13), DECODE COUNTER(IC28) for convert 10MHZ to 1MHZ, EEPROM(IC12), FS MOD EM(M2), DDS(M1), AUDIO AMPLIFIER(IC20), MUX/DEMUX(IC24) for controlling LCD CONTRAST.

And it controls SRG-1150DN/SRG-1250DN on the whole, such as operation of TX/RX, switch, front LCD and etc.

Control unit has function to make signal to need in controlling of synthesizer part had a outbreak according to PANEL operating of control unit, function of information-exchange and function of indication-control.

It is composed of MICRO COMPUTER of 16Bit.

a) MICRO COMPUTER be set by operating PANEL and set synchronizing circuit responded by receiving frequency (selecting channel).

And then, according to receiving frequency, set information setting frequency for SYNTHESIZER or REF/BFO.

In addition, MICRO COMPUTER pass signal (LOCAL CONTROL) to indicate various information(receiving frequency, receiving mode, band, width) set by operating panel of controller unit and transmit in control unit.

Except this function, in case of interception of power or supply-cease, MICRO COMPUTER control memory degaussing to be back-up by battery built.

Memory status before normal of power and in case of normal, possible to rebuild.

10.11 FRONT (T-568)

This PCB circuit is composed of switch, LED, voice, sensitivity modulator.

10.12 W/K RECEIVER UNIT(T-552)

Receiving method is 1st intermediate frequency(49.455MHz), DOUBLE-SUPER HETERODYNE TYPE of 2nd intermediate frequency(455KHz).

All local signal of receiver is supplied from DIGITAL CONTROL FREQUENCY

SYNTHESIZER through PHASE LOCKED LOOP(PLL) system and direct system to use 10MHz center oscillator(supplied from DTCXO : SSB GENERATOR circuit).

a) Receiving signal in ANTENNA terminal pass BK RELAY and input and voltage protecting circuit and pass band-pass filter and is closing in DSC distress safety frequency.

FILTER is separated from inner MICRO COMPUTER to response in receiving CHANNEL.

b) Receiving signal to pass filter passes 35MHz low band passing-filter and amplify by high-frequency amplifier of width band and is supplied in first mixture part.

First mixture part is balance type of gate earth and receiving signal is converted to 49.455MHz of 1st intermediate frequency to mix with 1 signal supplied from 49.455MHz to 79.45499MHz from SYNTHESIZER Converting output pass CRYSTAL FILTER of center frequency 49MHz passing band about 15KHz and amplify through 1st intermediate amplifier and is supplied in 2 mixture part.

Receiving signal as 2 mixture part is mixed with 2 signal supplied from

SYNTHESIZER unit and converted to 2nd frequency 455KHz.

c) Receiving signal amplified through 2 intermediate frequency amplify is supplied from AGC circuit and mixing circuit.

AGC voltage picked up from AGC circuit be feed back in 2 step of amplifier of 1 intermediate frequency and amplifier of 2 intermediate frequency and control benefit of each amplifier.

Receiving circuit supplied from mixture circuit is mixed with BFO supplied from SYNTHESIZER circuit and mixed.

Mixing output is supplied from DSC mixture unit.

*** DSC MIXING UNIT

DSC mixing unit is to pick up DOT PATTERN moved in DSC distress alarm signal and is composed of FILTER circuit, mixing circuit or micro processor for DOT PATTERN JUDGE.

a) FILTER CIRCUIT is receiving 2KHZ-8 LOW PASS SC-FILTER.

Each transmitted signal is to be limited and is sent to judging circuit of DOT PATTERN. In judging circuit of DOT PATTERN , is mixed like Software every 10mS.

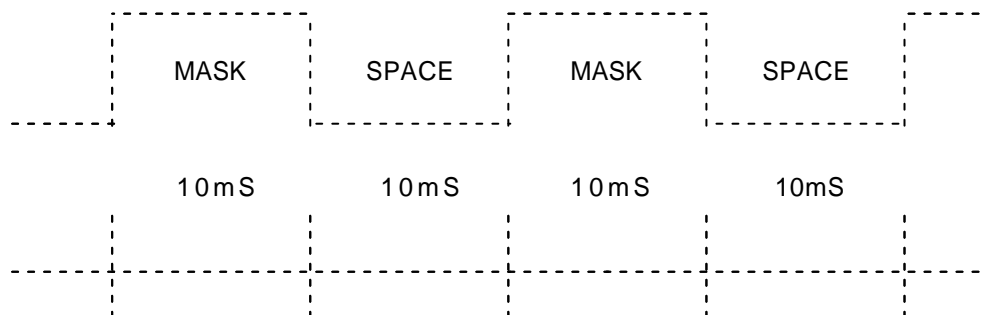

DOT PATTERN

MICRO COMPUTER do a sampling signal transmitted from LIMITING circuit per 1mS and judge whether is appliance with DOT PATTERN.

In case of being appliance with DOT PATTERN MICRO COMPUTER, MICRO COMPUTER output DOT DET signal about DSC equipment.

Output of receiving frequency information for LED LIGHT of DOT PATTERN IN PROGRESS in panel side, scanning- cease, output of receiving frequency is carried on CPU circuit T-557.

RESET of circuit picking DOT PATTERN carry on RESET signal from DSC equipment.

Timing of DOT DET-signal is follow.

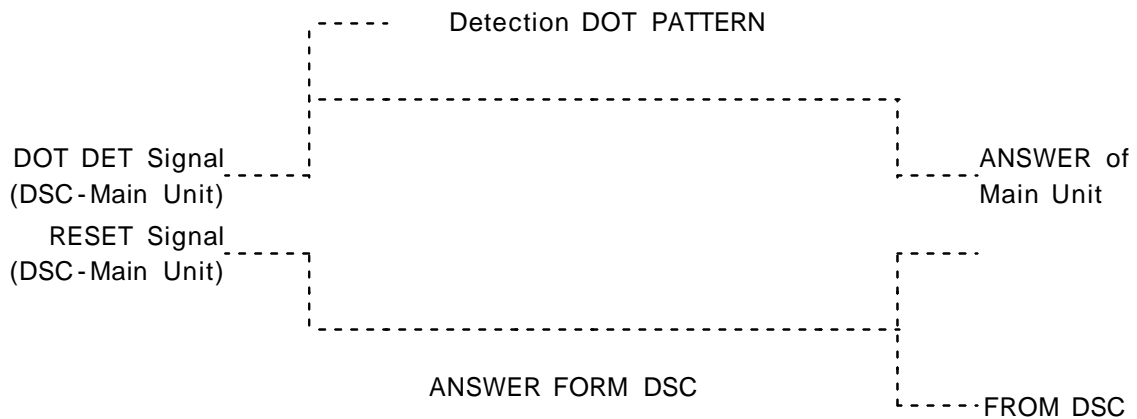

TIMING OF DOT DET SIGNAL and RESET SIGNAL

10.13 FUNCTION DIAGRAM OF REAR SIDE

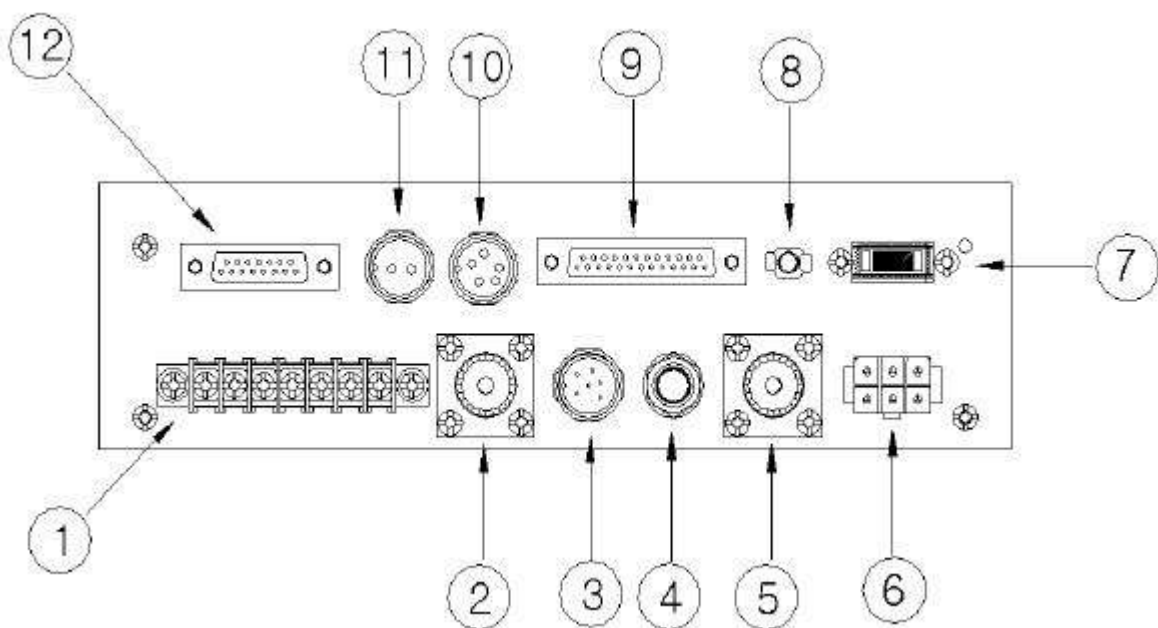

CONNECTOR : TO CONNECT PRINTER POWER(8V), GPS DATA,
BK+/- CONNECTOR, ATT AND ETC.

MF/HF ANT : IMPEDANCE 50-75 MF/HF RECEIVING ANTENNA INPUT JACK.

ATU : ATU CONTROL CONNECTOR

EXT.JACK : EXTERNAL SPEAKER CONNECTING JACK

W/K ANT : IMPEDANCE 50-75 W/K RECEIVING ANTENNA JACK.

CAR CONNECTOR : SUPPLY CONNECTOR FOR EQUIPMENT POWER

SUPPLY(+24V).

FUSE : 30A FUSE

GND : RECEIVER SYSTEM GROUND.

PRINTER : PRINTER CONNECTOR

ALARM BOX : CONNECTOR WHICH WITH CONNECTED WITH SD-250

AC/DC DETECTOR : POWER UNIT AC/DC DETECTION

TERMINAL CONTROL : CONNECTOR BETWEEN SRG-1150DN/SRG-1250DN AND
SN-100(NBDP TERMINAL).

11. NBDP TERMINAL

11.1 NBDP TERMINAL MAIN UNIT

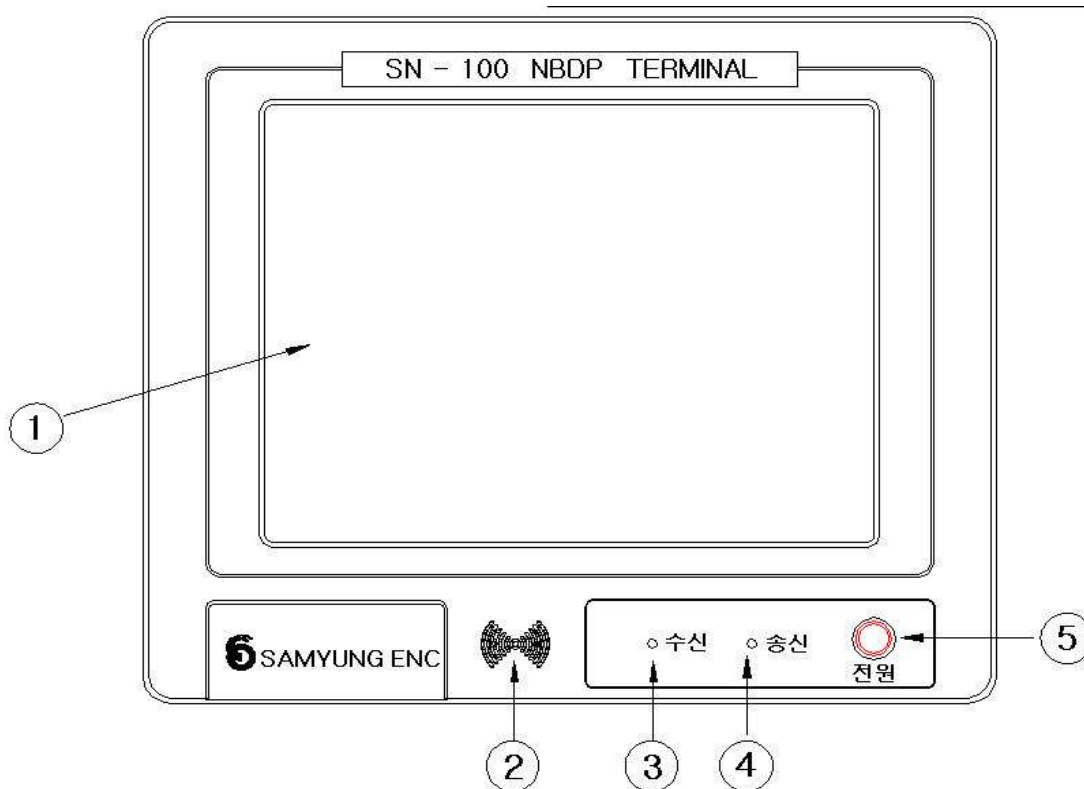

FRONT PANEL (LCD) : CHANNEL, TX/RX FREQUENCY, RF.GAIN, CLARIFY, ATT
AGC, AND FUNCTION KEYS ARE DISPLAYED.

SPEAKER : ALARM RINGS WHEN IT RECEIVES DATA OR WARNING SIGNAL.

TX LED : RED LIGHT ON TX LED

RX LED : GREEN LIGHT BLINKS WHILE RECEIVING DATA

POWER SWITCH : SN-100 POWER ON/OFF

11.2 FIRST DISPLAY OF TELEX(NBDP) MODE

* Power on, indicate first display as followings.

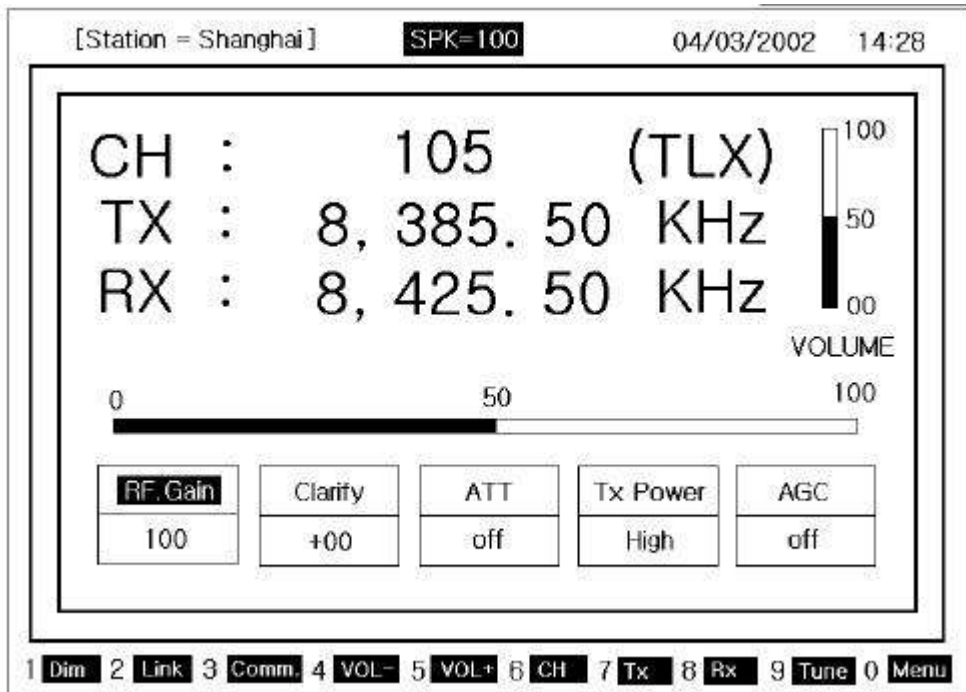

CH	Indicate calling channel and present channel
TX	Set transmitting frequency
RX	Set receiving frequency
BAR GRAPH	Indicate adjusting portion as Bar Graph
RF GAIN	Adjust the portion of RF GAIN properly using up/down with direction keys. (0~1steps)
CLARIFY	Adjust the number properly using up/down direction key. (± 10 Hz)
ATT	Adjust attenuator 4 steps using up/down direction key.

Tx Power

Adjust Tx power HIGH/MID/LOW.

AGC

Profit of input signal ON/OFF automatically.

Vol GRAPH

[[FUNCTION KEY]]

- F1** DIM : Adjust the lightness of back light on LCD display.(5 LEVEL)
- F2** LINK : Set Automatic Repeat Request mode and FEC mode.
- F3** COMM. : Call the registered frequency.
- F4** Volume down the speaker.
- F5** Volume up the speaker.
- F6** CH : Set the frequency channel
- F7** TX : Set Tx frequency.
- F8** RX : Set Rx frequency.
- F9** TUNE : is used when user want to do matching to antenna.
- F10** MENU : Indicate Main Menu
- [ARQ] : Communicate with Automatic Repeat Request Mode.
 - [FEC] : Communicate with 1 way Forward Error Correction.
 - [Station Edit] : Register the frequency of the other station.
 - [Station Print] : Print out the frequency of registered the other station.
 - [Macro Command] : Write Macro command
 - [Editor] : Edit file and save content
 - [System Set] : Use while adjusting TELEX mode condition.
 - [NBDP Test] : Transmitting signals of Dot, Mark, Space.
Use for testing printer and NBDP TX/RX condition.

[[The Other CONTROL FUNCTION]]

- PgUp : Adjust channel to next channel. But, if next channel is not registered, it moves to next channel of it.
- PgDn : Adjust channel to forward channel. But, if forward channel is not registered, it moves to forward channel of it.

11.3 SETTING UP TX/RX FREQUENCY

* UNIT : kHz

(1) Setting Tx frequency

- a) Press [F7] key on the keyboard.
- b) Input the frequency with number key.
(While inputting frequency if press [], [], curser will move.)
- c) Press [ENT]
NOTE!!) Available TX Freq. range : 1.6MHz ~ 27.5MHz

(2) Setting Rx frequency

- a) Press [F8] key.
- b) Input the frequency with number key.
(While inputting frequency if press [], [], curser will move.)
- c) Press [ENT]
NOTE!!) Available RX Freq. range : 95KHz ~ 29.99999MHz

(3) Setting TX/RX Freq. by Comm.

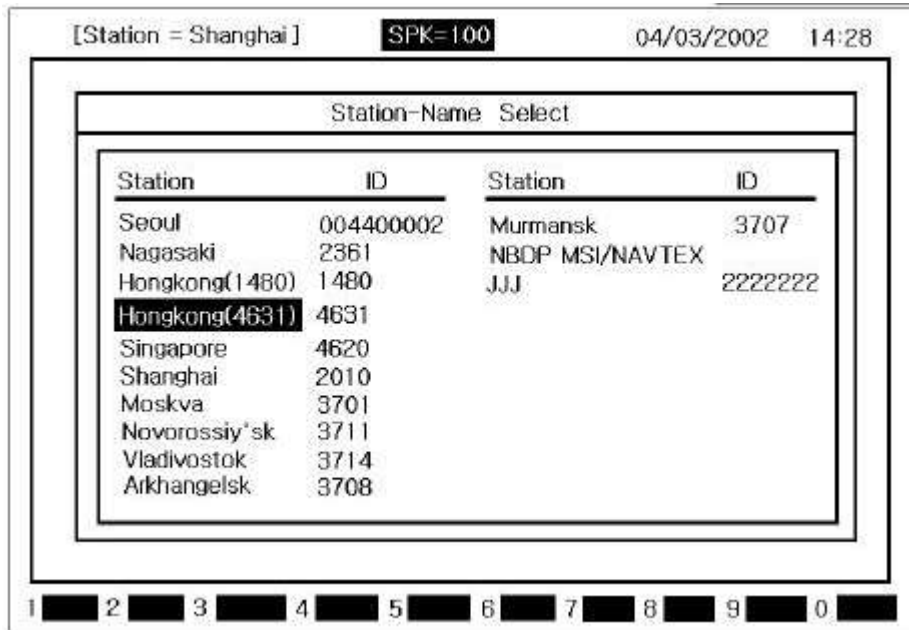

- Press [F3] key, display as followings.
- Revert the other station you want to communicate using [], [] key.
And then press [ENT] key, display as followings.

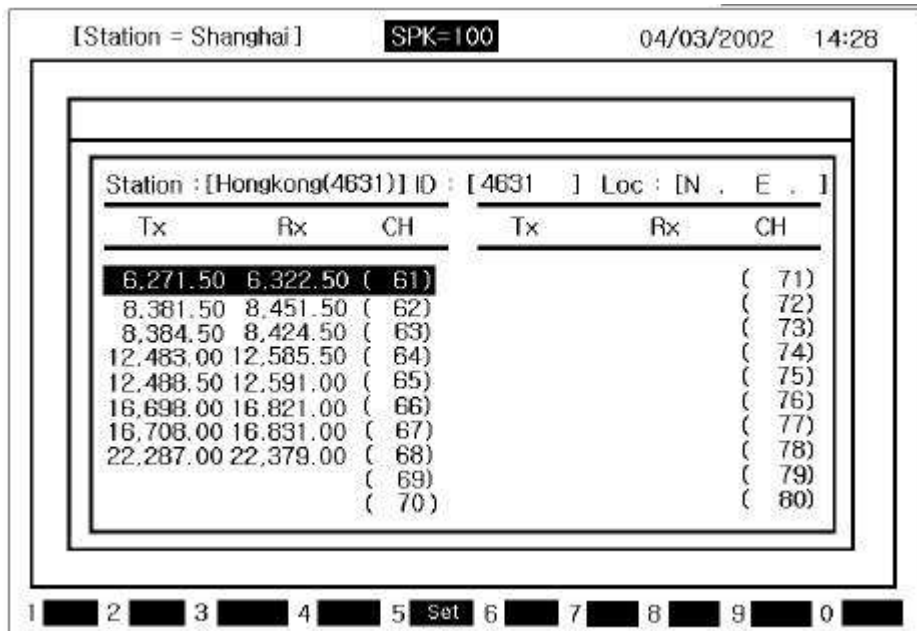

- Revert the channel you want to communicate using [], [] key.
And then press [ENT] key.
Set TX/RX frequency to registered freq. on channel displaying the first display of NBDP.

- (4) Setting TX/RX Freq. by calling channel
- Press [F6].
 - Input the channel with Number keys.
 - Press [ENT] key.

11.4 [ARQ] MODE

- (1) Connecting with the other station by ARQ mode.
 Connecting by present adjusting channel.
- Press [F2] key, displaying as following screen.

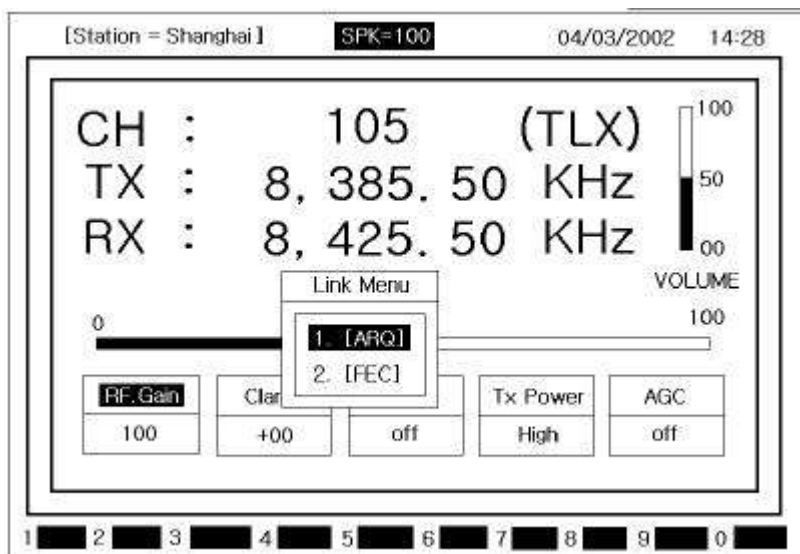

- Select [ARQ] and press [ENT], then it will be connected with other party through ARG mode in present setting Channel.

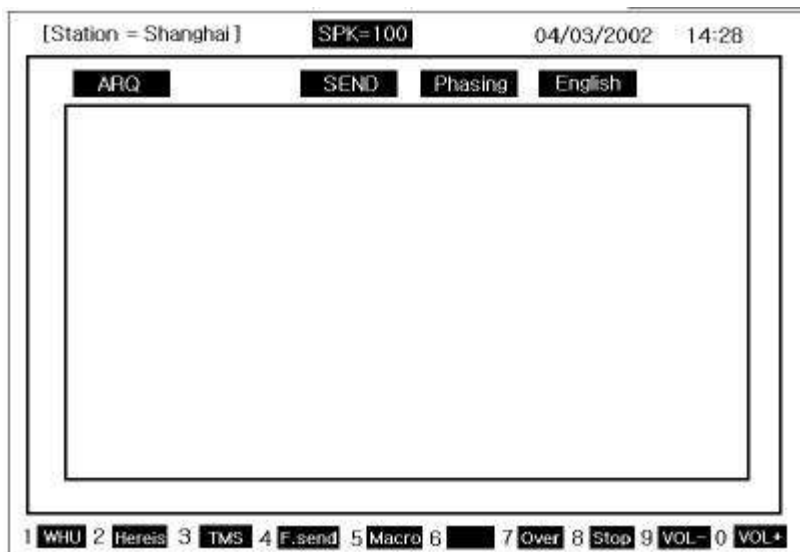

Connecting specific station

a) Call the menu pressing [F10] to call SUB MENU.

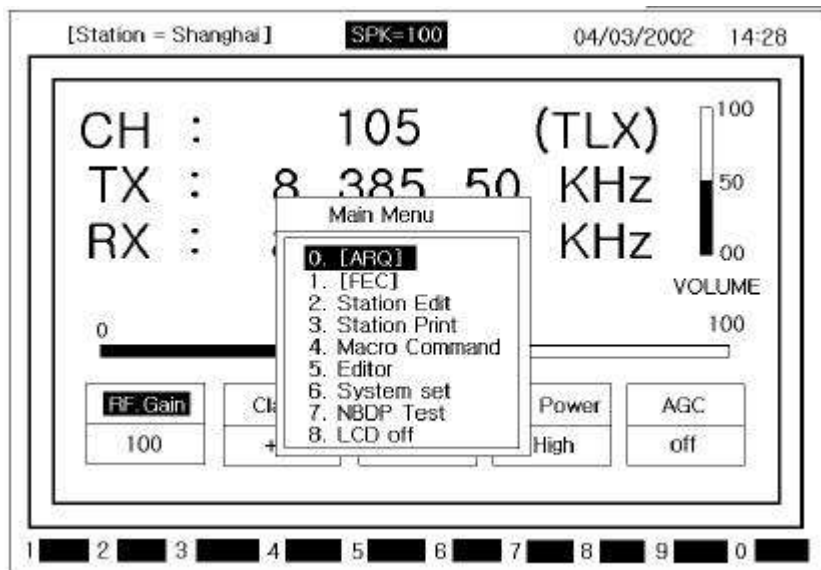

b) Select ARQ from the above menu, press [ENT] then display the screen as follow.

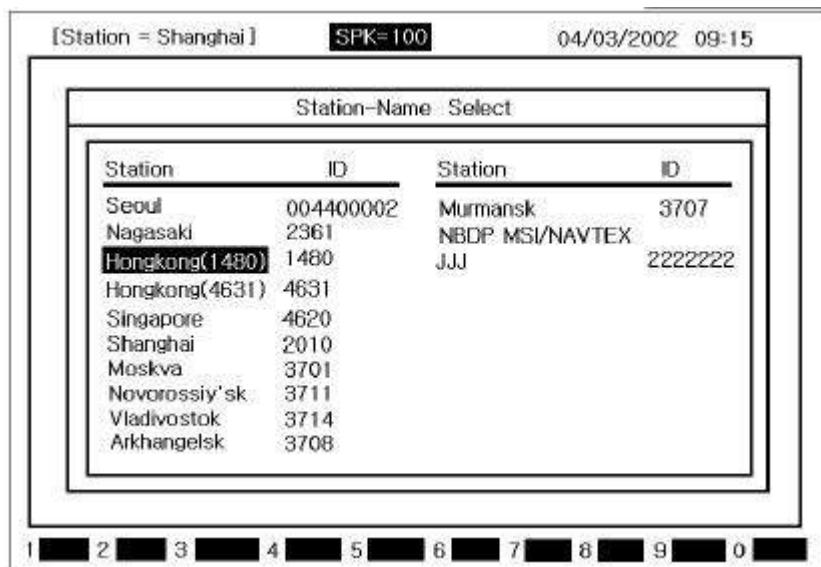

c) Select the specific station you want, press [ENT] then display the screen as follow.

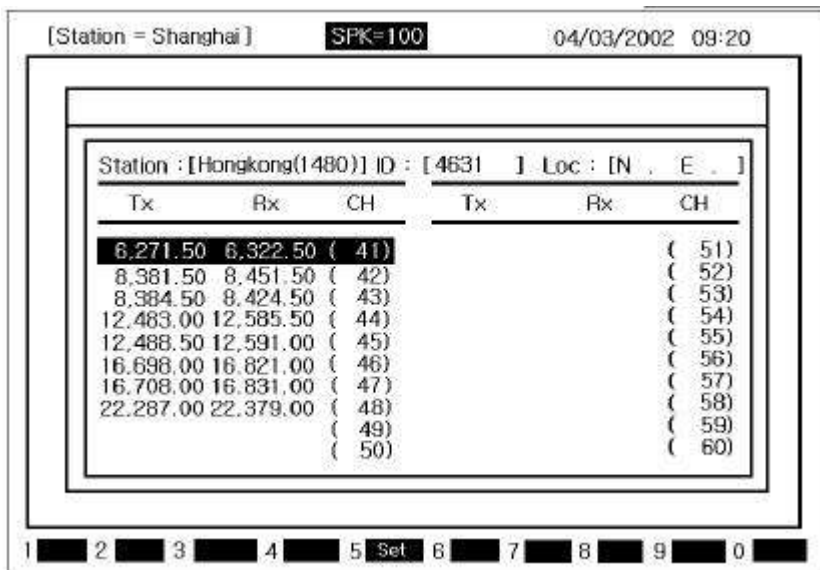

* Can be back to forward display pressing [ESC] key.

d) Select the channel you want to use with [], [] key, then press [ENT].

e) Call the other station with selected frequency displaying next [ARQ] mode first display.

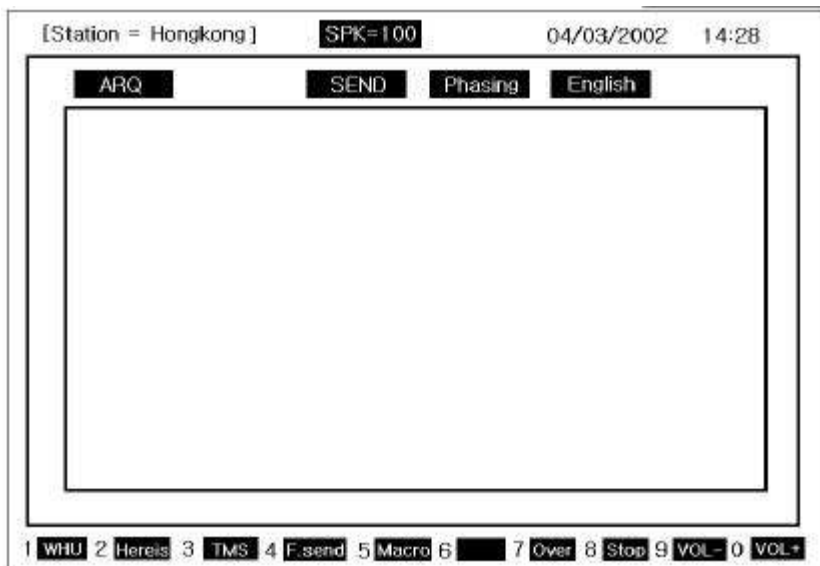

* If you want to make calling stop, can be back to the Telex first display by pressing [F8].

f) In case that the connecting is done properly, you can see the cursor in the left-up side of the screen.

(2) Communication in ARQ mode

* After done above (1), communicate with using below functions.

- a) As long as you can connect with the other station in ARQ mode, above screen is displayed. You can keep communicating in this condition.
- b) After typing the message with keyboard, press [ENT] key.
 - * Back space - delete one character on the left.
Before you press [ENT] key, transmitting is not complete.
- c) Press function key to use each function.
- d) Can transmit Macro Command in written in [F5].

(3) Usable keys in ARQ mode

* The usable characters

ABCDEFGHIJKLMNOPQRSTUVWXYZ1234567890

-?()., '=/+abcdefghijklmnopqrstuvwxy

- * Back space - Delete one character on the left.
- * Enter - Send one line.
- * Shift(on the left) + Space - Convert language. (English, Russian)
NOTE!!) It is possible while the present language is Russian only.
- * F1 : 'WHU' - Demand Answer back code of the other station.
- * F2 : 'Hereis' - Transmit Answer back code of yourself.
- * F3 : 'TMS' - Transmit the present time.
- * F4 : 'F.Send' - Transmit the file written in edit mode. (Refer to (4) TX of file)
- * F5 : 'Macro' - Transmit Macro Command
- * F7 : 'Over' - Convert the direction of transmitting the message.
- * F8 : 'Stop' - Stop communication.
- * F9 : 'VOL-' - Volume down
- * F 10 : 'VOL+' - Volume up

(4) Transmitting file

* After done above (1), follow the operation as below.

- a) Press [F4] and after selecting the file using [],[] key, press [ENT].
- b) Can be transmitted displaying the contents of the file on the screen.
 - * Pressing [F8] key is able to stop transmitting .

(5) Transmitting of Macro Command

* After done (1), follow the operation below.

- a) Press [F5] and after selecting the command, press [ENT].
- c) Can be transmitted displaying contents of Command on the screen.
 - * Pressing [F8] is able to stop transmitting.

11.5 [FEC] MODE

(1) Connecting the other station by Selective FEC mode.

* Communication with present selecting Channel.

a) Press [F2] and display screen as below.

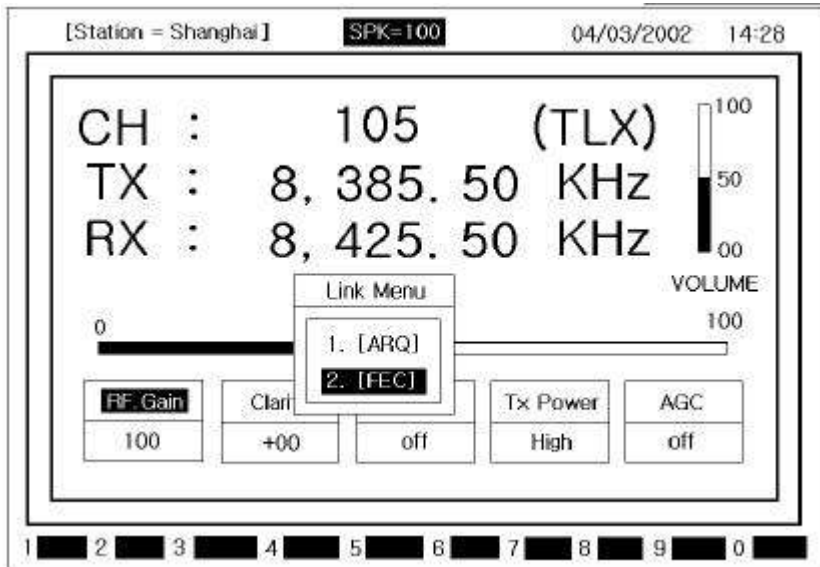

b) Select [FEC] and press [ENT], then below screen is displayed.

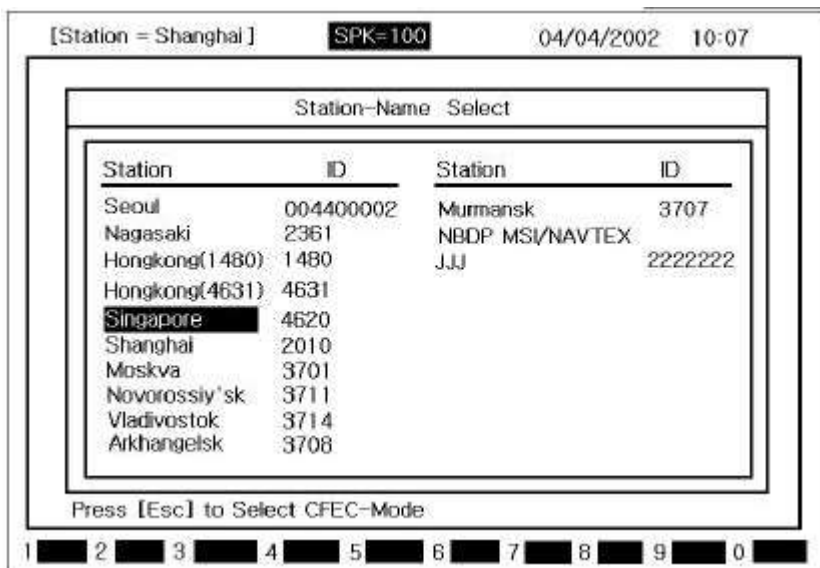

- c) Select the other station you want to communicate and press [ENT].
Then below screen is displayed.

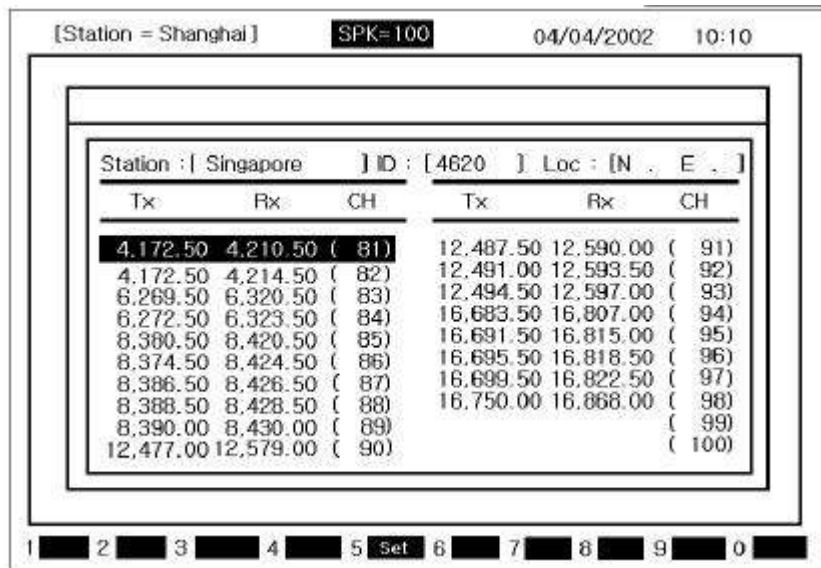

* To be back to forward display, press [CLR] key.

- d) After selecting the channel, press [ENT] key.
e) Can call the other station in the channel you selected displaying the first screen in [SFEC] mode.
* To stop calling , press [F8].



- f) As long as connecting with the other station, a curser will be displayed on the left-up side of the screen.

- (2) Connecting with the other station by collective FEC mode
 a) Call SUB menu with pressing [F10].

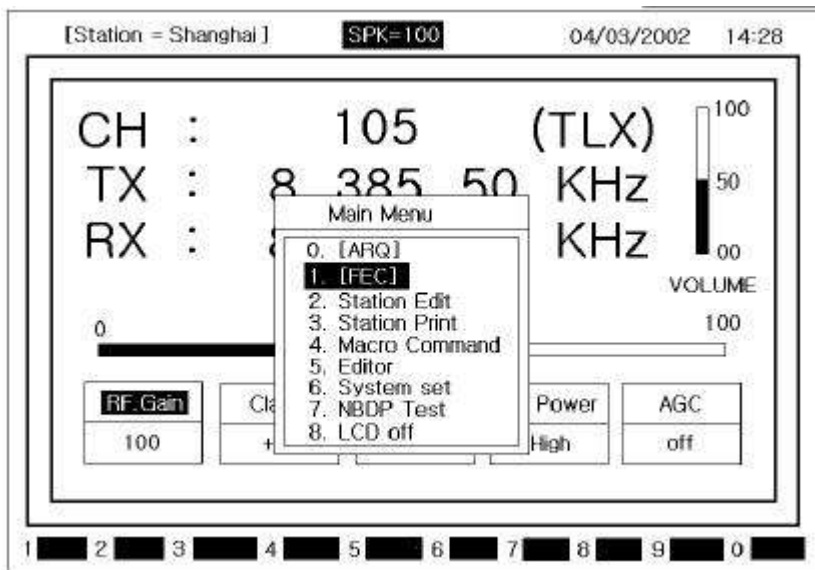

- b) After selecting [FEC], press [ENT] key. Then follow display is showed.

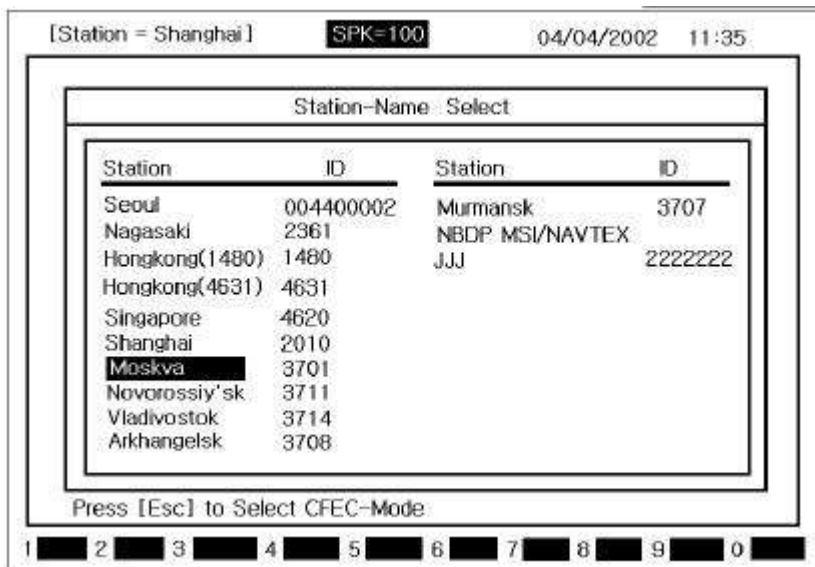

c) If you press [Esc] key, you can see following display.

Selected channel is displayed indicating the first display of [CFEC] mode.



* To stop calling, press [F8]. Then it is changed to first display of Telex .

d) Indicating the cursor in the left-up side on the screen means that it's connected with the other station.

(3) Communication in FEC mode

* After done above (1) or (2), follow the communicating operation.

(a) As long as connecting with the other station in FEC mode, [FEC] mode first display is showed. Communication is available under this condition.

(b) After typing message with keyboard, press [ENT] to send.

* Back space - Delete one character on the left side.

Transmitting is not available unless you press [ENT] key.

(c) To use each function, press function keys.

(d) Can transmitting Macro command written in [F5].

(4) Usable keys in FEC mode

* The usable characters

ABCDEFGHIJKLMNOPQRSTUVWXYZ1234567890

-?()., '=/+abcdefghijklmnopqrstuvwxy

* Back space - Delete one character on the left.

* Enter - Send one line.

* Shift(on the left) + Space - Convert language. (English, Russian)

NOTE!!) It is possible while the present language is Russian only.

* F2 : 'Hereis' - Transmit Answer back code of yourself.

- * F3 : 'TMS' - Transmit the present time.
- * F4 : 'F.Send' - Transmit the file written in edit mode.
(Refer to (5) TX of file)
- * F5 : 'Macro' - Transmit Macro Command
- * F8 : 'Stop' - Stop communication.
- * F9 : 'VOL-' - Volume down.
- * F10 : 'VOL+' - Volume up.

(5) Transmitting file

- * After done above (1) of (2), follow the operation as below.
- a) Press [F4] and below screen is displayed.

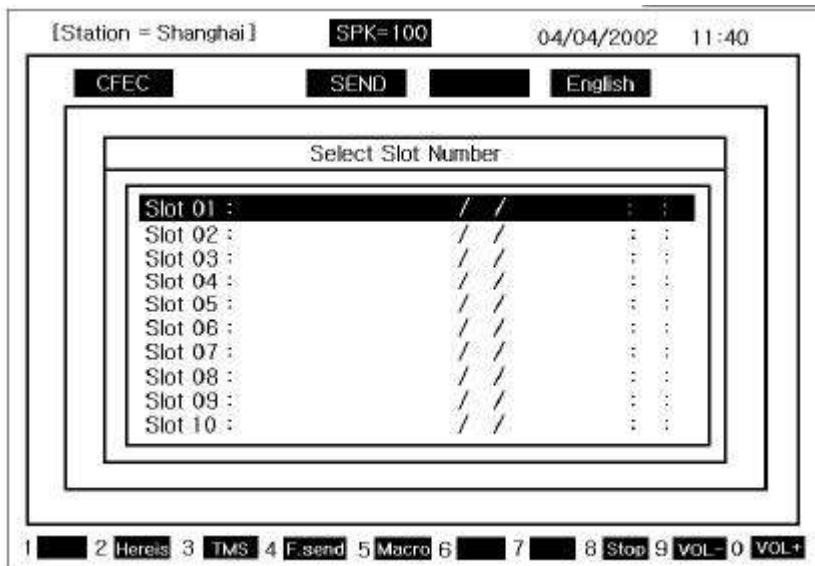

- b) After selecting the file using [], [] key, press [ENT].
- c) Can be transmitted displaying the contents of the file on the screen.
- * Pressing [F8] key is able to stop transmitting .

(6) Transmitting of Macro Command

- * After done (1) or (2), follow the operation below.
- a) Press [F5].
- b) After selecting the command, press [ENT].
- c) Can be transmitted displaying contents of Command on the screen.
- * Pressing [F8] is able to stop transmitting.

11.6 OTHER SEA STATION OR SHIP STATION EDIT & RESISTER FREQUENCY

a) Call the SUB menu pressing [F10].

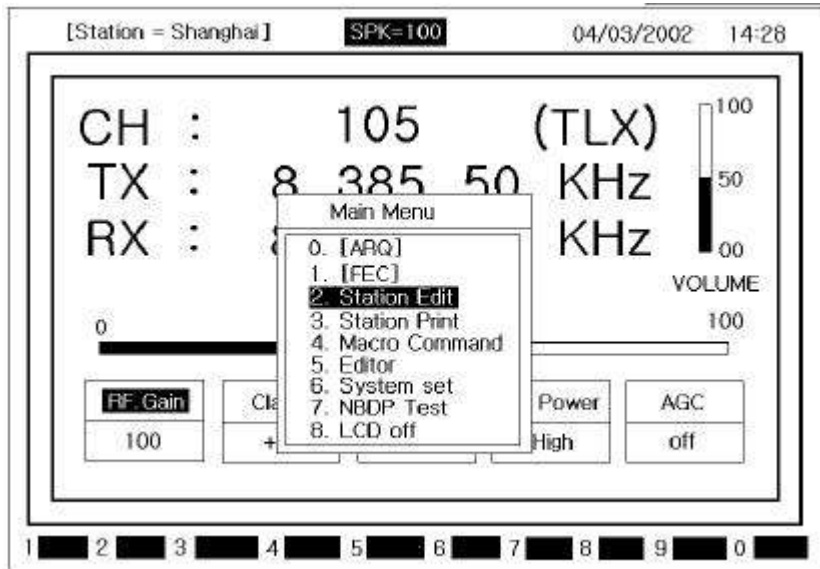

b) After selecting Station Edit, press [ENT]. Then following is displayed.

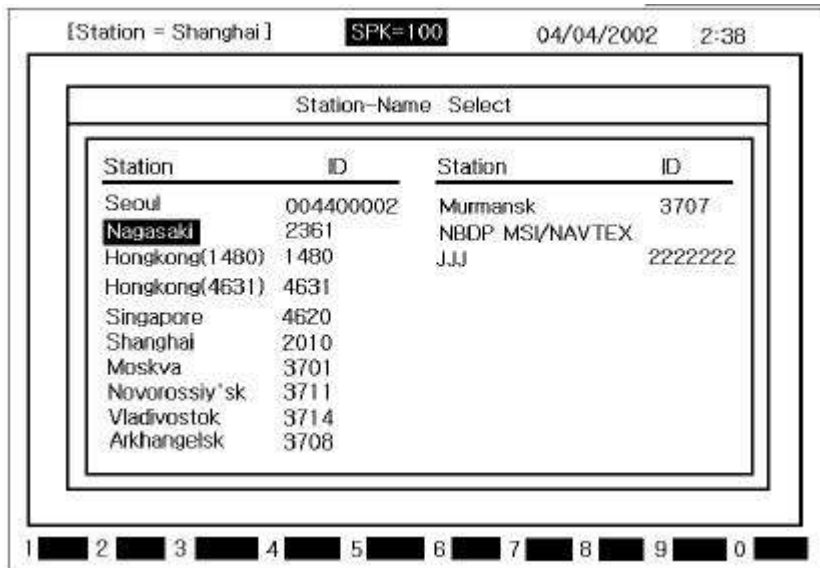

- c) After selecting the other station you want to communicate, press [ENT]. Then following is displayed.

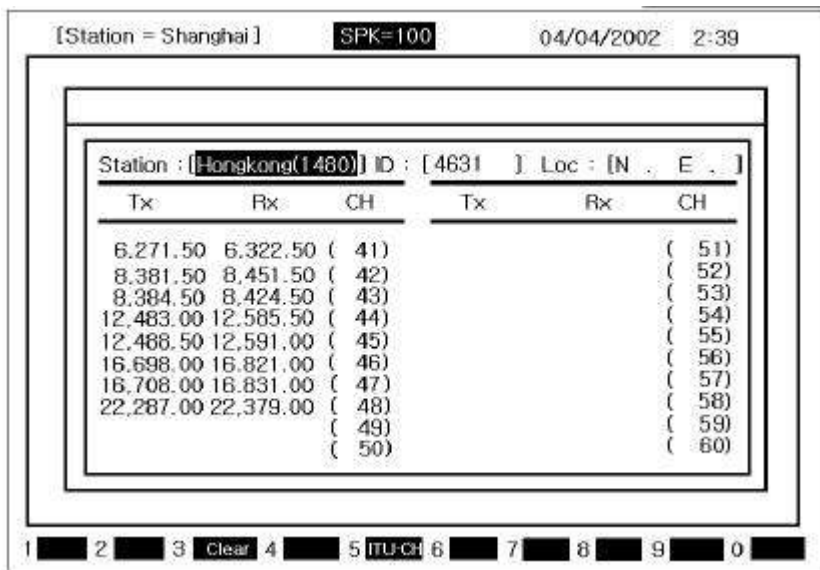

The screenshot shows a handheld device display with the following information:

- Top status bar: [Station = Shanghai] SPK=100 04/04/2002 2:39
- Main display area:

Station : [Hongkong(1480)]			ID : [4631]	Loc : [N . E .]		
Tx	Rx	CH	Tx	Rx	CH	
6.271.50	6.322.50	(41)			(51)	
8.381.50	8.451.50	(42)			(52)	
8.384.50	8.424.50	(43)			(53)	
12.483.00	12.585.50	(44)			(54)	
12.488.50	12.591.00	(45)			(55)	
16.698.00	16.821.00	(46)			(56)	
16.708.00	16.831.00	(47)			(57)	
22.287.00	22.379.00	(48)			(58)	
		(49)			(59)	
		(50)			(60)	
- Bottom status bar: 1 [] 2 [] 3 Clear 4 [] 5 ITU-CH 6 [] 7 [] 8 [] 9 [] 0 []

- d) After selecting station, press [ENT].
- e) After inputting name of Station, press [ENT].
- f) After selecting ID, press [ENT].
- g) After inputting ID, press [ENT].
- h) After selecting the channel, press [ENT].
- i) After inputting Tx Freq., press [ENT].
- j) After selecting Rx channel, press [ENT].
- k) After inputting Rx Freq. press [ENT].
- l) Press [ESC] key to change to the first display.

11.7 STATION PRINT

a) Call the SUB menu pressing [F10].

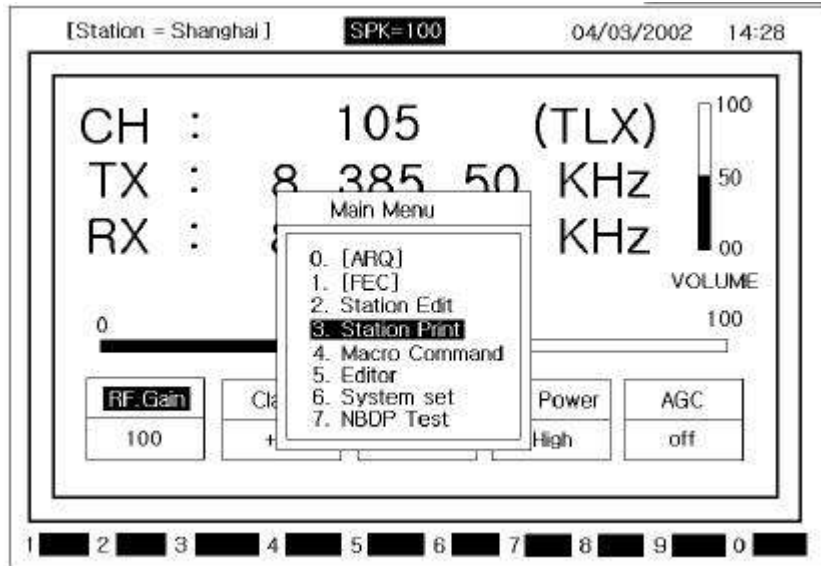

b) After selecting Station Print, press [ENT]. Then following is displayed.

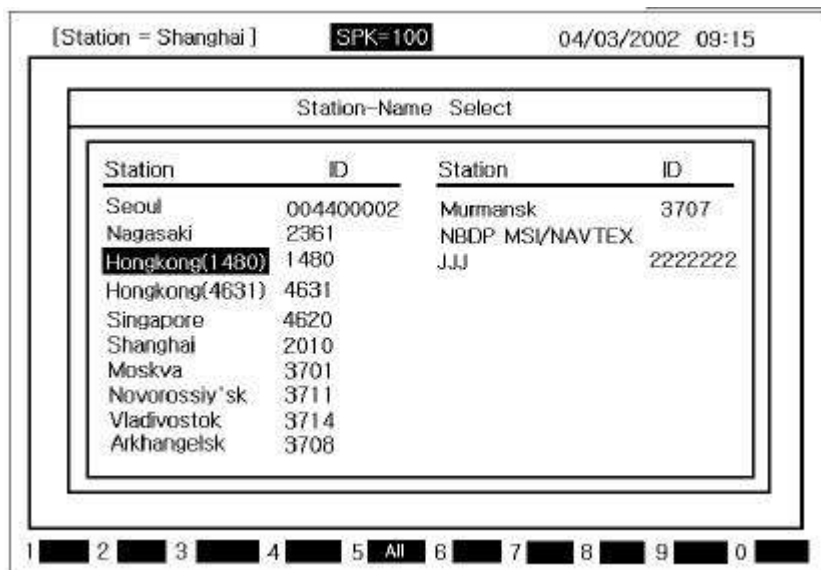

c) After selecting the other station you want to communicate, press [ENT].
Then selected frequency of the other station is printed.

11.8 REGISTRATION OF MACRO COMMAND

a) Call the SUB menu pressing [F10].

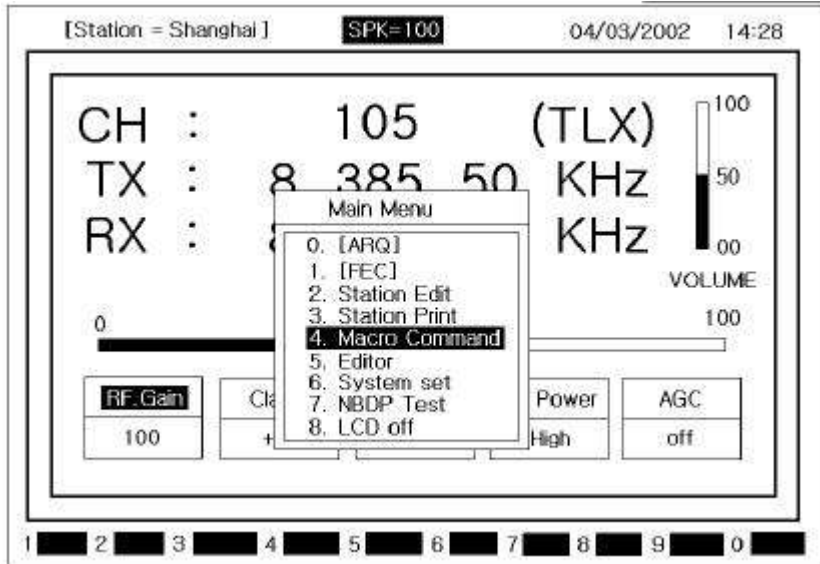

b) After selecting 'Macro Command', press [ENT]. Then the following is displayed.

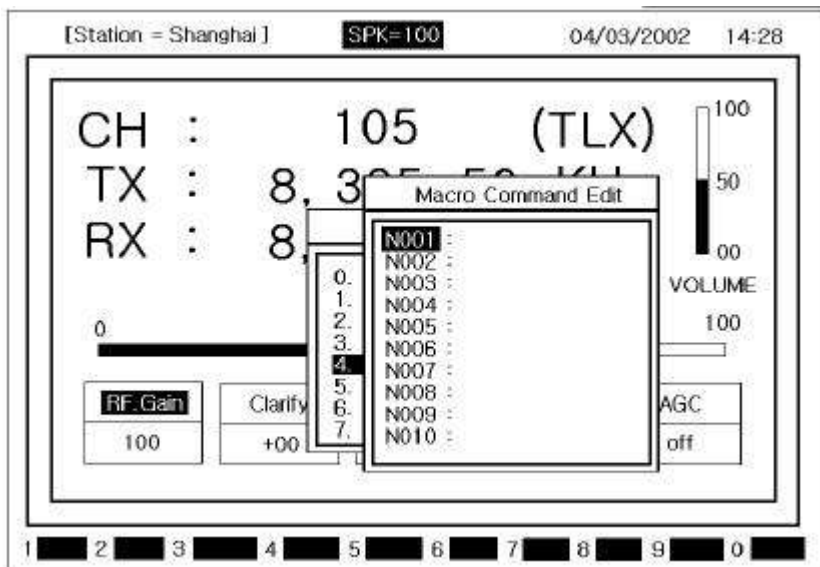

c) Select the number of Command using [], [], [], [].

d) After inputting 'Command' by keyboard, press [ENT].

11.9 EDITOR MODE

a) Call the SUB menu pressing [F10].

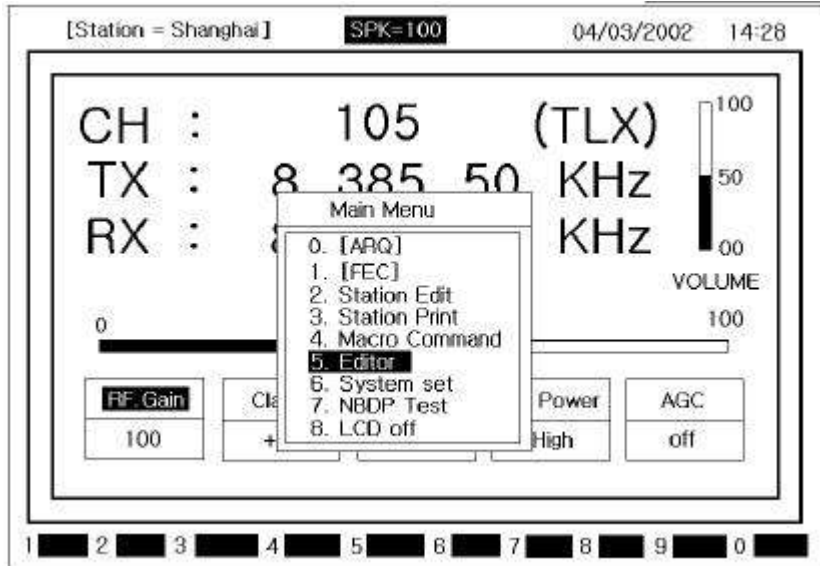

b) Select Editor and press [ENT], then following screen is displayed.

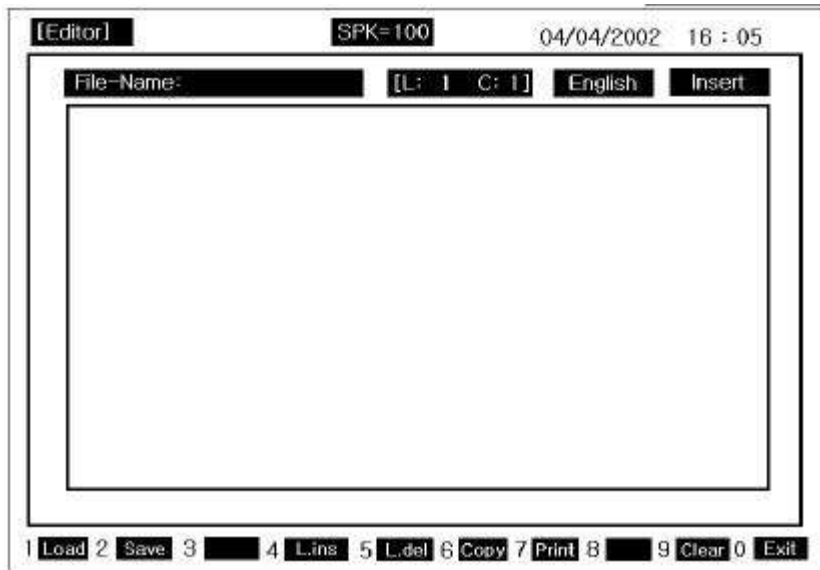

c) Writing and modifying contents is possible.
In order to finish, press [ENT].

11.10 INITIAL SETTING OF SYSTEM SET

a) Call the SUB menu with pressing [F10].

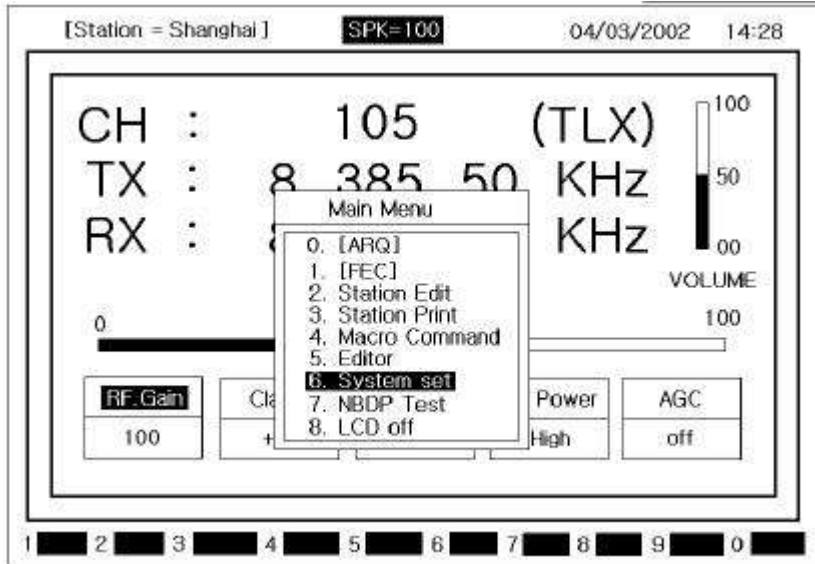

b) After selecting System set, pressing [ENT]. Then the following is displayed.

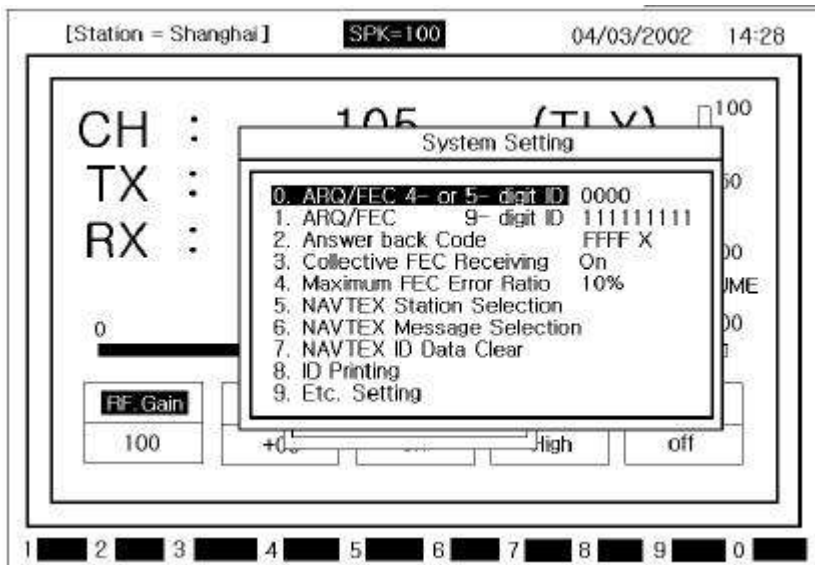

- | | |
|-----------------------------|-----------------------------|
| 0. ARQ/FEC 4- or 5-digit ID | 1. ARQ/FEC 9-digit ID |
| 2. Answer Back Code | 3. Collective FEC Receiving |
| 4. Maximum FEC Error Ratio | 5. NAVTEX Station Selection |
| 6. NAVTEX Message Selection | 7. NAVTEX ID Data Clear |
| 8. ID Printing | 9. Etc. Setting |

(1) Setting of ARQ/FEC 4- or 5-digit ID

* It is fixed when the equipment is set. It's impossible to change by user.

(2) Setting of ARQ/FEC 9-digit ID

* It is fixed when the equipment is set. It's impossible to change by user.

(3) Setting of Answer Back Code

* After done above (1), follow the operation below.

- a) Select Answer Back Code.
- b) After inputting Code, press [ENT] key.

(4) Setting of Collective FEC receiving

* It is fixed when the equipment is set. It's impossible to change by user.

- a) Select Collective FEC Receiving.
- b) If you press [ENT], turned On/Off by turns.

(5) Maximum FEC Error Ratio

* After doing as follow (1), operate the procedure as below.

- a) Select Maximum FEC and press [ENT].
- b) While receiving letters in FEC mode, if error ratio is over specific setting rate, receiving is stoped automatically.
(Ex. If it is set as 30%, when error ratio is over 30% and receiving is stoped.)

Setting of ARQ/FEC 4- or 5-digit ID

* It is fixed when the equipment is set. It's impossible to change by user.

(6) Selecting NAVTEX STATION

* After doing as follow (1), operate the procedure as below.

- a) Select NAVTEX station and press [ENT].
- b) Able to set initial message of NAVTEX. (A~Z)
 - O : indicate as initial message of NAVTEX.
 - X : doesn't indicate as initial message of NAVTEX.

(7) Selecting NAVTEX message

* After doing as follow (1), operate the procedure as below.

- a) Select Navtex Message and press [ENT].
- b) Whether receiving message or not is selectable.
But, A, B, C, D are being received continuously.

(8) NAVTEX ID Data Clear

* After doing as follow (1), operate the procedure as below.

a) Press [ENT] and showed [Yes] [No]. If [Yes] is selected, data is removed and

if [No] is selected, it goes backward.

(9) Printing of ID of yourself

* After done above (1), follow the operation below.

a) Select ID Printing.

b) Press [ENT] to print ID of yourself.

(10) Etc. Setting

* After done above (1), follow the operation below.

a) Select Etc. Setting and press [ENT]. Then below screen is displayed.

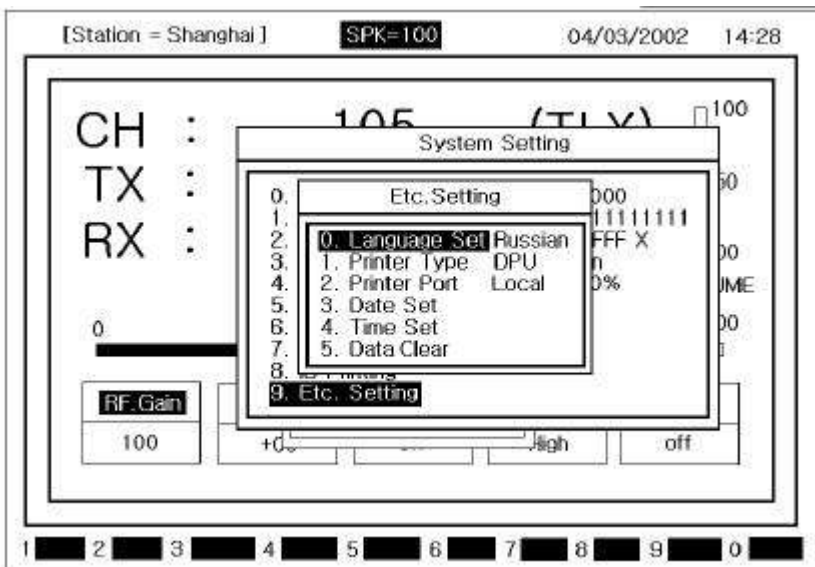

b) In order to reset the menu, press [ENT].

- 0. Language : Can select the language among KOR, ENG, RUSSIAN.
- 1. Printer Type : OKI printer or DPU-414
- 2. Printer Poter : Local(printing from main unit) or REMOTE(printing from terminal).
- 3. Date Set : Set the date.
- 4. Time Set : Set the present time.
- 5. Data Clear : Can erase memory data or data of Edit-File.

11.11 NBDP TEST

a) Call the SUB menu pressing [ENT].

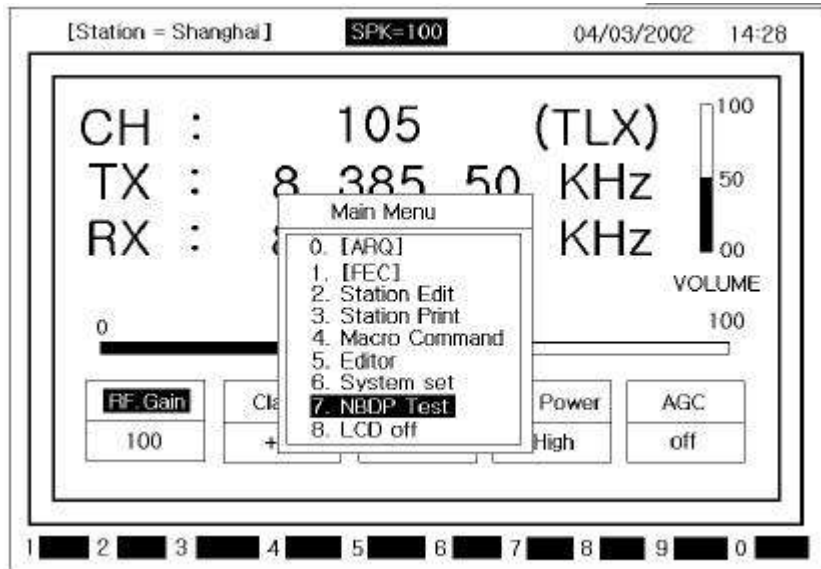

b) Select NBDP Test and press [ENT], then the following is displayed.

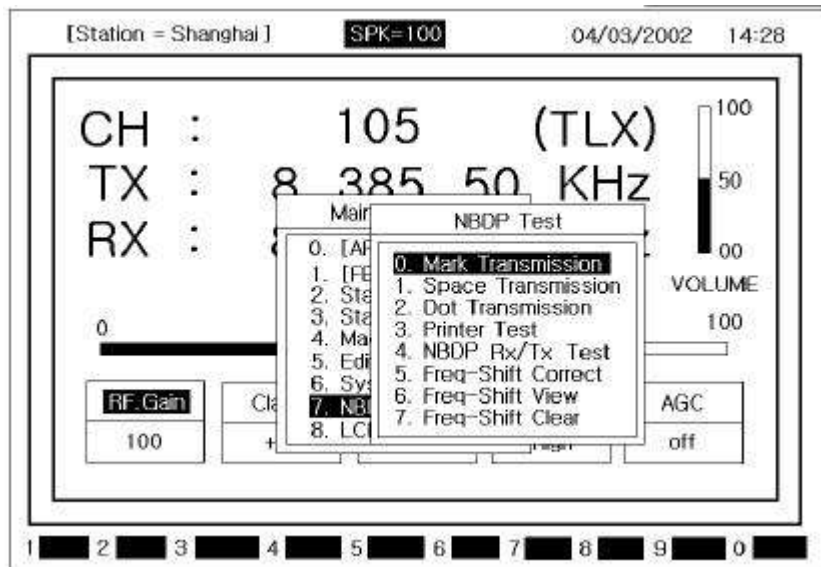

- (1) Mark transmission - Transmitting signal of 1.7KHz-85Hz 40 sec.
- (2) Space transmission - Transmitting signal of 1.7KHz+85Hz for 40 sec.
- (3) Dot transmission - Transmitting signal of 1.7KHz±85Hz for 40 sec.
- (4) Printer Test - Check printer condition by doing test printing.
- (5) NBDP Rx/Tx Test - Check NBDP terminal condition by transceiving the signal.
- (6) Freq-Shift Correct - The function which receiving 14MHz+1400Hz from receiving terminal and correct terminal 1st LOCAL frequency.

- (7) Freq-Shift View - shows how much correction has done after doing Freq-shift Correct.
- (8) Freq-Shift Clear - Clear the frequency correction.

Warning while using the function of Freq-Shift Correct
 Main unit and Terminal unit should be pre-heated.
 Test NBDP RX/TX and check it is O.K.
 Check Freq Freq-Shift View.

11.12. LCD OFF

- a) Call the SUB menu with pressing [F10]. Then the following as display.

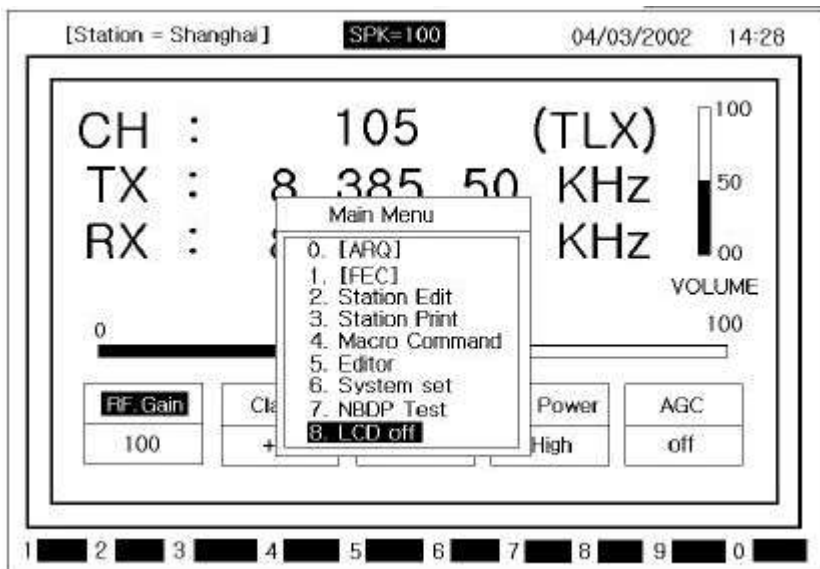

- b) To off LCD select LCD Off and press [ENT].
- c) Even LCD is turned off, other functions are available and if key is pressed or receive the data, then LCD is turned on.

12. NBDP TERMINAL CIRCUIT

12.1 OVERVIEW

SN-100 consists of NBDP Receiver, MOTHER BOARD, CPU BOARD, PLL BOARD and Power supply.

There are SRG-1150DN/SRG-1250DN connector, W/K receiving connector, printer connector, TX ANT RF cable connector, EARTH Plate, EMG lamp connector in the down part of rear side.

12.2 CONNECTION BOARD(T-020)

T-020 is PCB which is connecting CPU BOARD and other PCBs.

12.3 NBDP Receiving unit(T-022)

T-022 PCB is NBDP receiving unit which consists of frequency filter and amplifier, MIXER, ATT, AGC, B.K control circuit.

12.4 PLL BOARD(T-023)

T-023 is SYNTHESIZER PLL PCB.

12.5 POWER CIRCUIT(T-025)

Power circuit consists of constant voltage circuit.

And while power on, it makes ON main power DC 24V, convert constant voltage +12V, +8V, +5V.

If it is over powered +32V, then power off. Prevention to reversing voltage circuit is built-in.

12.6 FUNCTION DIAGRAM OF REAR SIDE

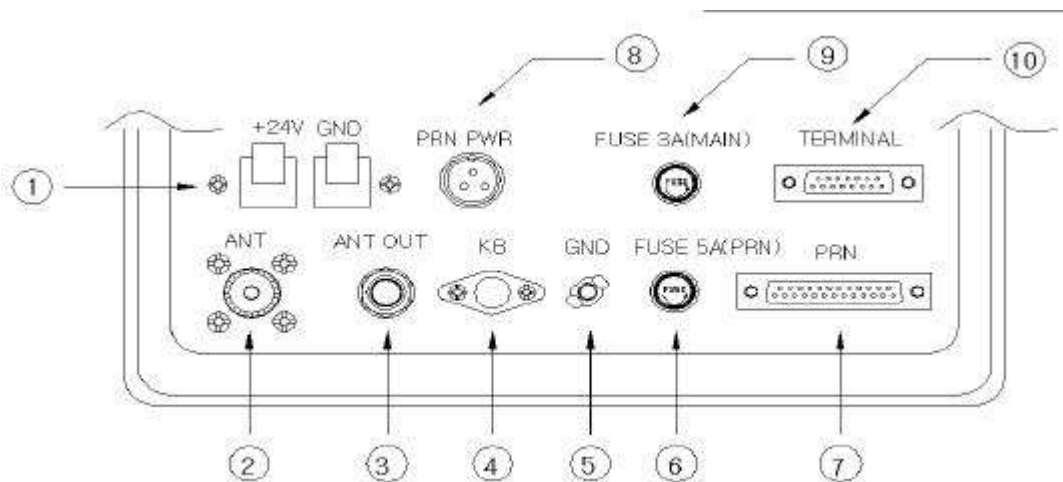

EMC : SUPPLY POWER +24 TO EMG LIGHT

RX ANT IN : IMPEDANCE 50 MF/HF RX ANT INPUT JACK

ANT OUT : CONNECT WHICH SEND W/K SIGNAL RECEIVED
FROM 'RX/ANT IN' TO MAIN UNIT

KEYBOARD : CONNECT BETWEEN KEYBOARD AND SN-100.
SUPPLY +5V, DATA, CLK ETC.

GND : RECEIVER SYSTEM GROUND

FUSE : 5A FUSE (PRINTER +24V FUSE)

PRINTER : CONNECT TO PRINTER

PRINTER POWER : CONNECTOR WHICH SUPPLIES +24V, +8V, GND
TO PRINTER

FUSE : 3A FUSE (POWER SUPPLY FUSE)

CONNECTOR TO MAIN UNIT : TRANSCIVING PTT IN, PTT OUT, READY,
DATA AF+, AF-.

13. TROUBLESHOOTING

13.1 OVERVIEW

Cause of TROUBLE in equipment, similar to mechanic cause and electronic cause appeared in external and inner of equipment.

These can be block by periodic check.

This function have various protecting circuit for trouble of external or inner and blocking damage of circuit and part.

However, in case of having trouble and damage, user have to find out problem.

ie, user should recognize first whether badness of equipment-self or external problem.

13.2 MEASURING INSTRUMENT

This equipment products for international radio telephone full maintenance & adjustment of this equipment have to control from correcting test center by rated testers must have testers for maintenance & adjustment daily follow as

1. multi-tester for check that don't need to be delicate ohm, voltage, current.
2. TEST PROBE that can be change from high-frequency signal to direct-current.
3. high-frequency transit power supply that can be check of travelling wave of until 1.6MHz ~ 27.5MHz band max 150W ~ 500W
4. 100MHz band max 150W, dummy load of 50
5. Frequency counter that can be check 100MHz band
6. OSCILLOSCOPE that can be check 100MHz band
7. other testers

13.3 MAINTENANCE & REPAIR

1. AIR ANTENNA

When happened interface (receiving sensitivity decreases, duplex communication interface) during installation or using, have to check the fault of air antenna for the first time.

- a) Check that air antenna control to vertical bearings (WHIP ANTENNA) correctly.
- b) Check that posit metal things around air antenna.
- c) Is it O.K connect condition & insulation of air antenna and connecting parts between transmitter - receiver.
- d) check the Travelling wave and reflection frequency after connect high-frequency power supply to transmitter - receiver and coaxial cable.

condition of air antenna, connector, coaxial cable is not good if standing wave(VSWR) become over 2:1 after product standing wave. if less than 2:1 after product standing wave, it's O.K.

2. POWER SUPPLY

Check power supply circuit even though volume & squelch control, not appear any sound and display at the front panel after connect power transmitter - receiver.

- a) check be cut the fuse after open fuse holder at the rear of transmitter - receiver. (fuse : 30A)
- b) Is it correct connect condition power connecting at rear of the transmitter - receiver. (Fuse be cut in case of power polarity supply opposit)
- c) Check power supply voltage at the power supply connector. If $24V \pm 10\%$ is (21.6~26.4V), it's correct. have to maintenance if over or less, the badness of power supply equipment(POWER SUPPLY or BATTERY)
- d) Change same goods if check power circuit T-555 PCB, it's badness.

3. TRANSMITTER

Check follow as when hand set is correct. when transmitter switch hand set can't receiver at the operating, check the connecting condition.

- a) Check Air antenna & power. can't receiver when channel selecting is incorrect or selected unpermitted channel.
- b) Check T-514(SRG-1150DN)/T-524(SRG-1250DN) and T-451(SRG-1150DN) /T-461(SRG-1250DN) PCB, if this part is not good, have to change.
- c) Not able to receive from unmatched channel and error sign is displayed.

4. RECEIVER

After check Each switch selecting is correct for the first time, check follow as ;

- A. Check connect of speaker after check air antenna or power.
- B. Check the PCBS T-454 and T-451(SRG-1150DN)/T-461(SRG-1250DN) equipment, if this part is not good, have to change same goods.
- C. Check to become OFF MODE, check MAIN or EXTERNAL speaker select correctly.

5. DSC Receiver

After check Each switch selecting is correct for the first time, check follow as ;

- a) Check air antenna connection for DSC.
- b) Check T-552 PCB or T-553 PCB of inside of equipment, if this part is not good, have to change same goods.

6. SWITCH and DISPLAY

According to manual, confirm error using or setting value and in case of no error, check as follows.

a) check T-568 PCB of equipment

In case of error, replacing same product

b) check connector and LCD or cable connected to T-568 PCB of or T-557 of equipment.

In case of error, replacing same product.

13.4 CAUTION

1. In case of checking transmitter unit, please contact dummy load.

2. In case of separating each PCB, pay attention to static electronic.

3. In case of modulating, use tools for modulation.

4. In case of checking or modulating, when measuring instrument contact in each circuit, user should match signal of the circuit and PROBE of measuring instrument.

5. In case of checking or modulating, pay attention to the difference when measuring instrument is connected into each circuit or not.

6. All maintenance had better be carried out in our agent or SAMYUNG ENC CO., LTD.